



User Guide

1140 Matrix Printer



Important Safety Instructions (English)

Read the following instructions thoroughly before starting up your printer.

- Never carry out maintenance or repair work yourself. Always contact a qualified service technician.
- Keep this Operator's Manual in a place which is easily accessible at all times.
- Place the printer on a solid and even base so that it cannot fall.
- Never place the printer in the vicinity of inflammable gas or explosive substances.
- Ensure the printer is connected to a socket with the correct mains voltage.
- Always disconnect the printer from the mains before opening the device to perform maintenance work or remedy errors.
- Do not expose the printer to high temperatures, direct sunlight or dust.
- Keep all liquids away from the printer.
- Protect the printer from shock, impact and vibration.
Make sure that the printer and computer are switched off before connecting the data cable.
- The print head will become very hot during printing; avoid contact with the print head after printing has finished.
- Do not perform any operation or action in any way other than those provided in this manual. When in doubt, contact your dealer or your customer support.



The device and mains-socket must all times be easily accessible.

Wichtige Sicherheitshinweise (German)

Lesen Sie bitte diese Sicherheitshinweise durch, bevor sie den Drucker in Betrieb nehmen.

- Führen Sie Wartungsarbeiten und Reparaturen keinesfalls selbst aus, sondern verständigen Sie immer einen qualifizierten Servicetechniker.
- Bewahren Sie diese Dokumentation an einem jederzeit zugänglichen Ort auf.
- Den Drucker auf stabilem und ebenem Untergrund so aufstellen, dass er nicht zu Boden fallen kann.
- Stellen Sie den Drucker keinesfalls in der Nähe von leicht entzündlichen Gasen oder explosiven Stoffen auf.
- Den Drucker nur an eine Steckdose mit der richtigen Spannung anschließen.
- Wenn Sie den Drucker vom Netz trennen wollen, den Drucker ausschalten und immer den Netzstecker an der Steckdose ziehen.
- Den Drucker weder hohen Temperaturen noch direktem Sonnenlicht und Staub aussetzen.
- Keine Flüssigkeiten mit dem Drucker in Berührung bringen.
- Den Drucker keinen Erschütterungen, Stößen oder Vibrationen aussetzen.
- Sicherstellen, dass der Drucker und der Computer ausgeschaltet sind, bevor das Datenkabel angeschlossen wird.
- Der Druckkopf wird während des Druckens heiß. Vor dem Berühren deshalb einige Zeit abkühlen lassen.
- Weichen Sie bei der Bedienung des Druckers nicht von den Anweisungen in der Dokumentation ab. Bei Unklarheiten wenden Sie sich bitte an Ihren Händler oder Ihren Kundendienst.
- Maschinenlärminformationen – Verordnung – 3.GPSGV, der höchste Schalldruckpegel beträgt 70 dB(A) oder weniger gemäß EN ISO 7779.



Das Gerät und die Netzsteckdose müssen jeder Zeit leicht zugänglich sein.

Consignes importantes de sécurité (French)

Lire attentivement les instructions suivantes avant de mettre l'imprimante en service.

- Ne jamais effectuer soi-même les travaux d'entretien et de réparations. Contacter toujours un dépanneur qualifié.
- Placer l'imprimante sur un support stable de façon à ce qu'elle ne puisse pas tomber.
- Ne jamais placer l'imprimante à proximité de sources de gaz aisément inflammables ou de substances explosives.
- Ne connecter l'imprimante à une prise que lorsque la tension est correcte.
- Pour déconnecter l'imprimante de l'alimentation principale, mettre l'imprimante hors tension et toujours débrancher le connecteur secteur de la prise murale.
- Ne pas exposer l'imprimante à des températures élevées, à la lumière directe du soleil ou à la poussière.
- Ne pas mettre l'imprimante en contact avec des liquides.
- Ne pas exposer l'imprimante à des chocs, impacts ou vibrations.
- S'assurer que l'imprimante et l'ordinateur sont hors tension avant de connecter le câble de données.
- La tête d'impression est brûlante pendant l'impression. C'est pourquoi laissez-la refroidir quelques instants avant d'y toucher.
- N'exécutez aucune opération ni action d'une autre manière que celle indiquée dans ce manuel. En cas de doute, veuillez contacter votre distributeur ou service après-vente.



Le dispositif et la prise principale doivent toujours être accessibles facilement.

Indicazioni di sicurezza importanti (Italian)

Prima di mettere in funzione la stampante, leggere attentamente le seguenti indicazioni.

- Non eseguire mai da sé gli interventi di manutenzione e riparazione, ma rivolgersi sempre a un tecnico di assistenza qualificato.
- Conservare le presenti istruzioni per l'uso in un luogo sempre accessibile.
- Collocare la stampante su una superficie stabile, per evitare che cada a terra.
- Non collocare la stampante in prossimità di gas facilmente infiammabili o di sostanze esplosive.
- Collegare la stampante a una presa di corrente con tensione adeguata.
- Per scollegare la stampante dalla rete di alimentazione, spegnere la stampante e disinserire sempre il connettore di rete dalla presa.
- Non esporre la stampante ad elevate temperature né alla luce solare diretta e alla polvere.
- Evitare il contatto della stampante con liquidi.
- Non esporre la stampante a colpi, scosse o vibrazioni.
- Verificare che la stampante e il computer siano spenti prima di collegare il cavo di trasmissione dati.
- Durante la stampa, la testina si surriscalda notevolmente. Prima di toccarla, se necessario opportuno quindi lasciarla raffreddare qualche istante.
- Non eseguire alcuna operazione o azione se non nella maniera descritta nel presente manuale. In caso di dubbio, contattare il rivenditore o dalla società incaricata dell'assistenza.



Il dispositivo e la presa di corrente devono essere sempre facilmente accessibili.

Instrucciones de seguridad importantes (Spanish)

Lea las siguientes instrucciones con esmero antes de poner la impresora en servicio.

- Nunca lleve a cabo trabajos de mantenimiento o reparación Ud. mismo, sino consulte a un técnico de servicio calificado.
- Guarde las presentes instrucciones de servicio en un lugar de fácil acceso en cualquier momento.
- Ponga la impresora sobre un base estable de manera que no pueda caer al suelo.
- Nunca coloque la impresora en la vecindad de gases de fácil inflamabilidad o sustancias explosivas.
- Asegure conectar la impresora sólo a un enchufe con un voltaje correcto.
- Cuando quiera desconectar la impresora de la red, apague la impresora y siempre tire la clavija de alimentación del enchufe.
- No exponga la impresora a temperaturas altas, a la luz solar directa y al polvo.
- No ponga la impresora en contacto con fluidos.
- Nunca exponga la impresora a sacudidas, choques o vibraciones.
- Asegúrese de que la impresora y el ordenador estén apagados antes de conectar el cable de datos.
- La cabeza de impresión se pone muy caliente durante la impresión. Por lo tanto, deje enfriarlo algún tiempo antes de tocarla.
- No permita que se realice cualquier operación o acción de una forma diferente a lo que se señala en el manual. En caso de duda, póngase en contacto con su comerciante o con su servicio post-venta.



El dispositivo y la toma de corriente deben estar ubicados de forma que sea fácil acceder a ellos.

Правила по технике безопасности. (Russian)

Прочитайте, пожалуйста, инструкцию по технике безопасности перед включением в работу принтера.

- Не выполняйте технические работы и ремонт техники самостоятельно, но сообщайте о неисправностях квалифицированным сервисным техникам.
- Данная инструкция должна быть всегда доступна каждому пользователю.
- Установите принтер на ровном и стабильном месте так, чтобы он не смог упасть на пол.
- Ни в коем случае не ставьте принтер вблизи легко воспламеняющихся газов и взрывчатых веществ.
- Включайте принтер в розетку только с соответствующим напряжением.
- Если Вы хотите отключить принтер от напряжения, сначала выключите принтер сам и затем выньте штекер из розетки.
- Берегите принтер от нагревания, от попадания на него прямых солнечных лучей и пыли.
- Не допускайте попадания жидкости на принтер.
- Нельзя подвергать принтер тряске, ударам и вибрации.
- Убедитесь, что принтер и компьютер выключены, только после этого соедините принтер с компьютером.
- Печатающая головка нагревается во время работы принтера. Поэтому подождите какое-то время, прежде чем дотронуться до нее.
- Пользуйтесь принтером так, как это написано в документации. Если у Вас возникают неясности, обращайтесь с вопросами к Вашим продавцам или в сервисный центр.



Устройство и розетка должны быть всегда легко доступна.

Instruções Importantes sobre Segurança (Portuguese)

Leia as instruções de segurança antes de usar a impressora.

- Consulte sempre um técnico qualificado para executar uma reparação .
- Coloque a impressora sobre uma base sólida e nivelada, para que ela não sofra quedas.
- Jamais instale a impressora nas proximidades de lugares onde haja gás inflamável ou substâncias explosivas.
- Assegure-se de conectar a impressora à tomada elétrica com a voltagem apropriada.
- Quando desligar a impressora da rede, desligue sempre a impressora e retire o cabo da tomada.
- Não exponha a impressora a temperaturas altas ou luz solar direta.
- Não aproxime substâncias líquidas da impressora.
- Proteja a impressora de choques, impactos e vibrações.
- Desligue a impressora e o computador antes de conectar o cabo da rede.
- A cabeça da impressora pode ficar muito quente . Portanto, espere algum tempo antes de tocá-la.
- Não faça nenhuma operação ou ação além das recomendadas neste manual. Em caso de dúvida, contate seu revendedor ou companhia de serviço.



A impressora e a tomada devem ser facilmente em todos os momentos acessíveis.

Önemli Güvenlik Talimatları (Turkish)

Lütfen, yazıcıyı işleme geçirmeden önce bu güvenlik talimatlarını bütünüyle dikkatle okuyun.

- Bakım ve tamir çalışmalarını kesinlikle ve hiçbir surette kendi başınıza yapmayın; her zaman kalifiyebir uzman servis-teknisyenine haber verin.
- Yazıcıyı, üzerinden yere düşmesi mümkün olmayacak sabit ve düz bir zemine yerleştirin.
- Yazıcıyı kesinlikle ve hiçbir surette kolayca yanabilecek gaz veya patlayıcı maddeler içeren nesnelere yakınına koymayın.
- Yazıcı akım kablosunu sadece doğru gerilime sahip bir prize takın.
- Yazıcıyı şebeke ağından ayırmak istediğinizde, yazıcıyı kapatın ve ağ-fişini her zaman prizden çıkartın.
- Yazıcıyı ne yüksek ısı ne de doğrudan güneş ışığına ve toza mâruz kalan mekânlarda bulundurun.
- Yazıcı hiçbir sıvı maddeyle temasta olmamalıdır.
- Yazıcı hiçbir sarsıntıya, darbeye veya titreşime mâruz kalmamalıdır.
- Veri kablosu bağlanmadan önce hem yazıcının hem de bilgisayarın kapalı olduklarından emin olmalısınız.
- Yazıcının başı basma esnasında yüksek ısıya ulaşıyor. Bu yüzden lütfen dokunmadan önce kısa süre soğumasını bekleyin.
- Yazıcının işletimi ve kullanımında bu dokümantasyondaki talimatların hiç dışına çıkmayın. Sorunlu görünen hususlarda lütfen imâlatçınıza veya müşteri hizmetleri servisimize başvurun.



Cihaz ve elektrik prizinin her zaman kolayca erişilebilir olması gerekir.

TRADEMARK ACKNOWLEDGEMENTS

“IBM” is a trademark of International Business Machines Corporation.

“EPSON” is a trademark of Epson America Incorporated.

“DEC” is a trademark of Digital Equipment Corporation.

“Centronics” is a trademark of Centronics Data Computer Corporation.

“DOS” is a trademark of Microsoft Corporation.

“SAP” is a trademark of SAP AG.

“Windows”, “Windows 7”, “Windows 8”, “Windows 95”, “Windows 98”, “Windows NT”, “Windows 2000”, “Windows 2003/2008/2012 Server”, “Windows XP” and “Windows Vista” are trademarks of Microsoft Corporation.

All other product names and company names appearing in this manual are the registered trademarks or trademarks of the individual companies.

TABLE OF CONTENTS

1 Unpacking Guide	1
1.1 Unpacking the Printer.....	1
1.2 Placing the Printer.....	2
1.3 Printer Components.....	3
2 Setting Up Printer	4
2.1 Install Ribbon.....	4
2.2 Install the Single Sheet Feeder.....	5
2.3 Connecting the Interface Cable.....	6
2.4 Connecting the Power Supply.....	7
2.5 Installing the Windows Driver.....	8
3 Paper Installation Guide	14
3.1 Adjusting the Print Gap Lever.....	14
3.2 Friction Feed Handling.....	14
3.3 Tractor Feed Handling.....	15
3.4 Continuous Paper Placement.....	16
4 Control Panel Operation	17
4.1 LED Indicators.....	17
4.2 Control Panel Keys.....	18
4.3 Panel Operation.....	19
4.4 Online State.....	20
4.5 Setup State.....	21
4.6 Power-On State.....	21
5 Printer Setting Changes	23
5.1 System Setup.....	23
5.2 Paper Setup.....	24
5.3 Interface Setup.....	26
5.4 Character Setup.....	27
5.5 Other Setup.....	28
5.5.1 German (Deutsch).....	28
5.5.2 Russian (Россия).....	30
5.5.3 Italian (Italiano).....	32
5.5.4 French (Français).....	33
5.5.5 Spanish (Español).....	35
5.5.6 Turkish (Türkçe).....	37
5.5.7 Portuguese (Português).....	38
5.6 Black Mark Parameters.....	41
5.7 Bidirectional Alignment.....	43
5.8 Restore Factory Default.....	44
5.9 Tally Dascom Printer Config Tool.....	45
6 Customized Form	46
6.1 Customize Cut Sheet Form Length.....	46
6.2 Customize Cut Sheet TOF.....	48

Tally Dascom 1140

6.3 Customize Cut Sheet Bottom Margin.....	48
6.4 Customize Cut Sheet Left Margin	49
6.5 Customize Fanfold Page Formatting Parameters	49
7 Maintenance.....	50
7.1 Cleaning.....	50
7.2 Cleaning and Vacuuming the Printer.....	50
7.3 Cleaning the Paper Rollers.....	51
8 Troubleshooting.....	52
8.1 Print Quality Problems and Solutions.....	52
8.2 Paper Handling Problems and Solutions	53
8.3 Operating Problems and Solutions	54
8.4 Printer Failures	54
8.5 Error Indications on LEDs.....	55
8.6 Diagnostic Functions.....	55
8.7 Firmware Update.....	56
9 General Specifications.....	58
10 Interfaces.....	61
10.1 Parallel Interface	61
10.2 USB Interface	62
10.3 Serial interface.....	62
10.4 Bluetooth interface	64
11 Character sets & Code Pages.....	68
11.1 Character Sets.....	68
11.2 Code Page Commands.....	73
11.3 Code Page Tables	74
12 Control Codes Summary	89
12.1 ESC/P2 Emulation Command List	89
12.2 IBM Emulation Command List.....	91
FCC STATEMENT.....	93

Symbols used

Important information is highlighted in this manual by two symbols.



CAUTION highlights information which must be observed in order to prevent injuries to user and damage to the printer.



NOTE highlights general or additional information about a specific topic.

1 Unpacking Guide

1.1 Unpacking the Printer

1. Place your packaged printer on a solid base.
2. Make sure that the “Up” symbols point in the correct direction.
3. Open the packaging, lift the printer out of the cardboard box and remove the remaining packaging material.
4. Check the printer for any visible transport damage and missing items. If you find any transport damage or if any accessories are missing, please contact your dealer. The following items are included:
 - Printer
 - Paper feed knob
 - Sheet feeder
 - Power cord
 - Ribbon cartridge
 - CD-ROM
 - Installation Guide
 - USB cable

Remove the packaging materials from the printer as follows:

1. Open and remove the top covers of the printer following the below picture.

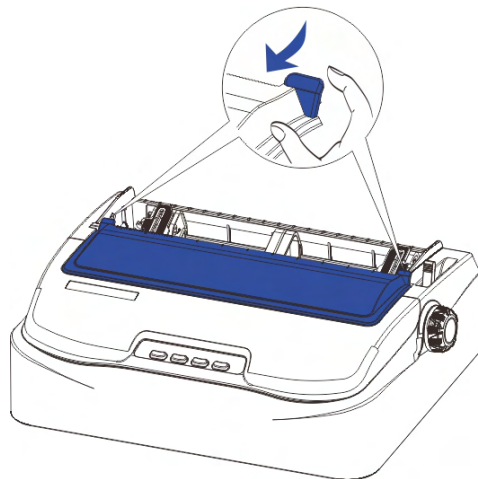

2. Remove the shipping cardboard from around the print head.

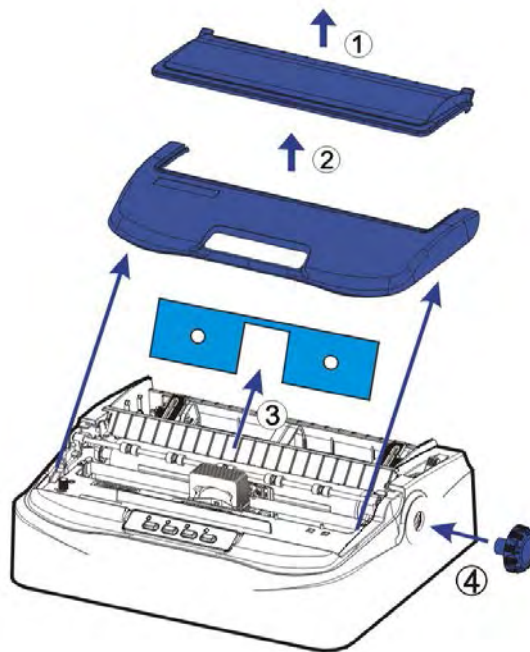

3. Install the paper feed knob. Rotate the paper feed knob to make it fix with the latch. And then press it to lock. (Step ④ of above picture)

1.2 Placing the Printer

Place the printer on a solid, flat, stable surface; ensuring that the printer is positioned in such a way that it cannot move, and that there is easy access to the control panel and paper input devices. Also ensure that there is enough space for sufficient ventilation and for the printed output.



When selecting the printer location, observe the following additional instructions:

1. Never place the printer near to any flammable gas or explosive substances.
2. Do not expose the printer to direct sunlight. If you cannot avoid placing the printer near a window, protect it from the sunlight with a curtain.
3. When connecting a computer to the printer, make sure the maximum recommended cable length is not exceeded.
4. Ensure sufficient distance between the printer and any heating devices/radiators.
5. Avoid exposing the printer to extreme temperature or air humidity fluctuations. Avoid exposure to dusty environments.
6. It is recommended the printer is installed in a position which reduces noise exposure to the work place during printing.
7. The power-outlet shall be installed near the equipment and shall be easily accessible.

Tally Dascom 1140

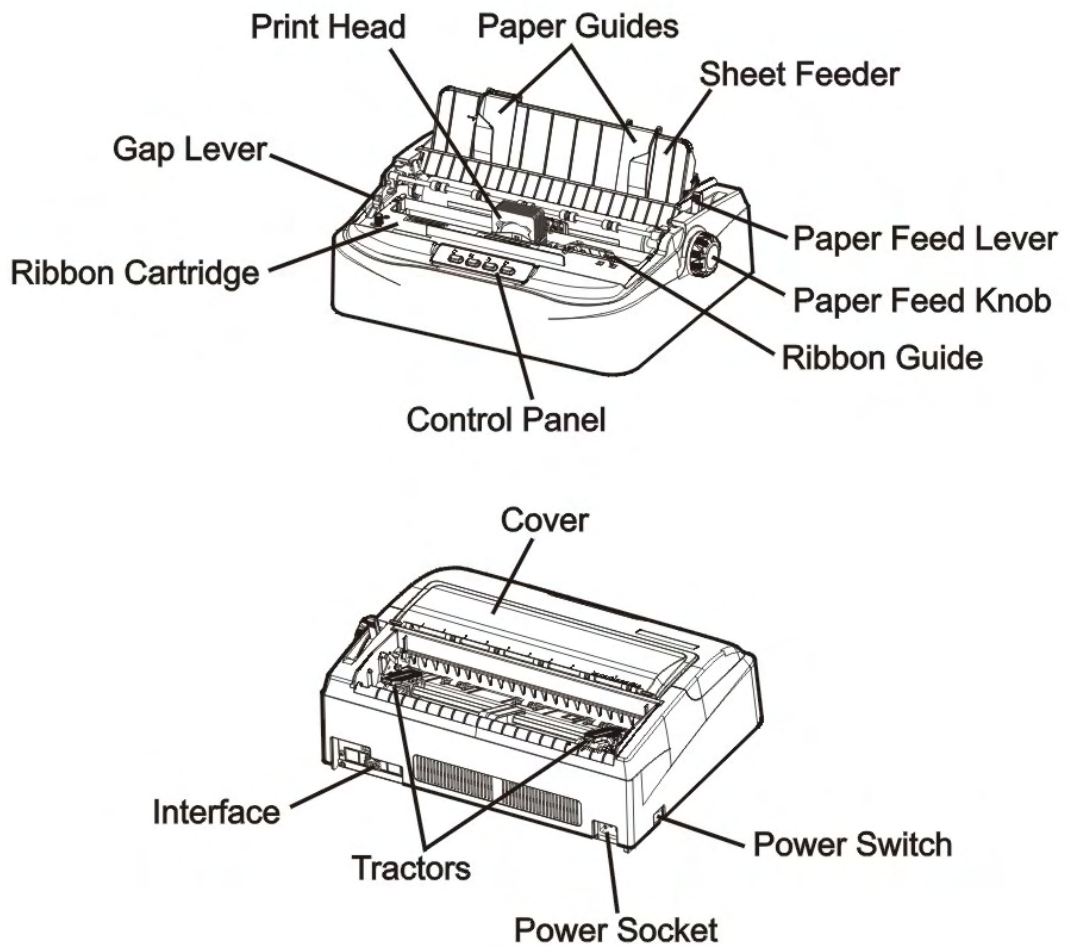
1.3 Printer Components



Component	Function
Gap Lever	Adjusts the print gap lever according to the thickness of paper
Paper Guides	Adjusts positioning of single sheet paper
Print Head	9-pin printing mechanism
Cover	Protects print head and other components inside, and reduce noise
Control Panel	Shows printer status, for printer setup
Paper Feed Lever	Two positions:  = continuous forms;  = single sheet paper
Paper Feed Knob	Manual feed or vertical positioning of paper
Power Switch	Power printer ON or OFF
Ribbon Cartridge	Install ribbon in the printer
Ribbon Guide	For guiding ribbon installation on print head
Tractors	For feeding and adjustment of continuous forms
Power Socket	Connects power cord to the printer
Interface	Connects interface cables from the host

2 Setting Up Printer

2.1 Install Ribbon

i Take special caution: The print head may be hot!

1. Ensure the power to the printer is off and the print gap lever “A” is set to the furthest open position. Move the carriage to the center of the print platen.
2. Install the recess positions ①-② on the ribbon cassette into the printer mounting.
3. Press the ribbon frame ③ onto the print head.
4. Turn the ribbon knob ④ in clockwise direction until the ribbon fabric is taut. Move the carriage left and right to ensure the carriage and ribbon fabric can move smoothly.
5. Ensure the print gap lever “A” is set to the original position.
6. Close the printer’s cover. When printer is in operation, ensure the printer’s cover is closed to keep the noise level to a minimum.

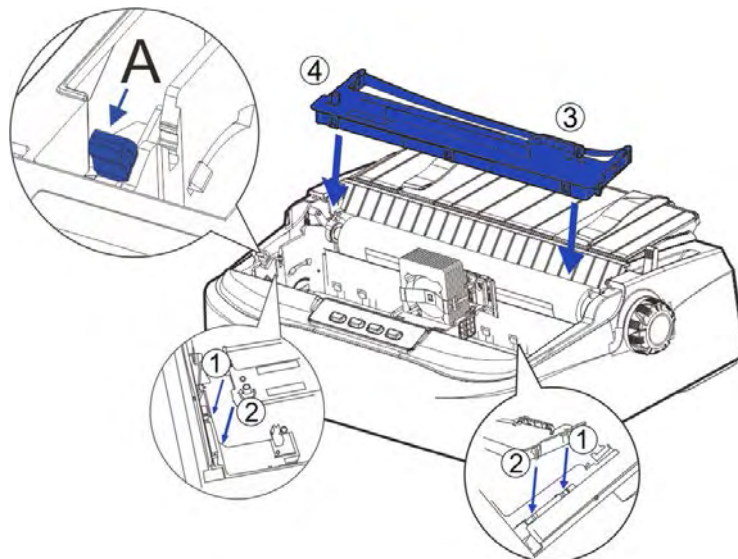

Notes on Ribbon Cartridge Removal:

1. Eject any paper loaded in the printer.
2. Turn off the printer power.
3. Open and remove the cover.
4. Set the gap lever to the most open position labeled “RIBBON”.
5. Move the carriage to the middle. Be careful not to touch the print head if printing had just been performed, as the print head may be hot.
6. Remove the ribbon frame from the print head.
7. Use fingers to take hold of the handle on the ribbon cartridge firmly, and lift the cartridge upwards to unlatch it. Some force may be needed to unlatch the cartridge.

2.2 Install the Single Sheet Feeder

Install the single sheet feeder into the rear of the printer. If you intend to use this paper way, assure having removed the fanfold paper out of the rear tractor paper way by pressing Eject way.

Then switch the paper feed lever to Single.

1. As shown in the picture below, unfold the Paper Guides first. Then put the Single Sheet Feeder into its installation position and push it down to latch.

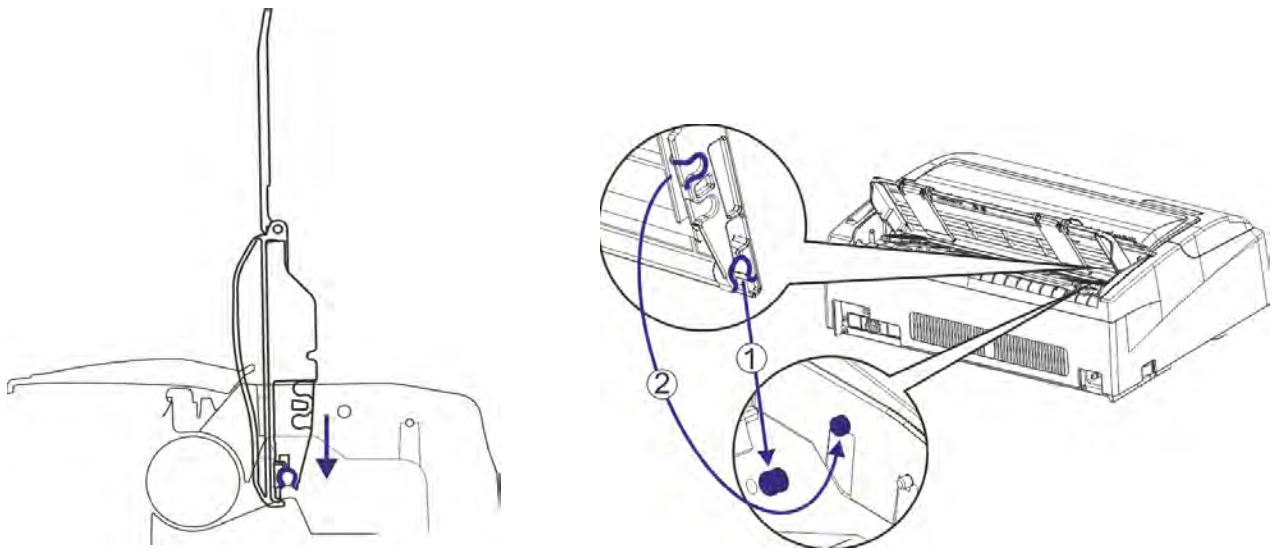

2. Push the Single Sheet Feeder backward to make it latch again.

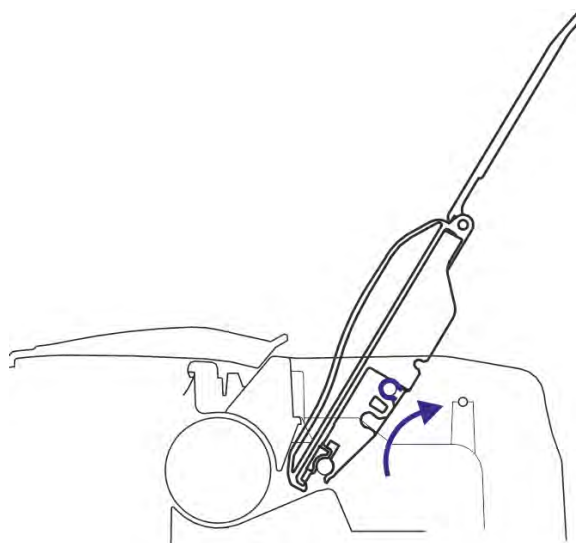

2.3 Connecting the Interface Cable

The USB port is located at the rear of the printer.

IMPORTANT: Make sure the printer and the computer are switched off before connecting or disconnecting the interface cable to prevent electrical damage to the interface ports.

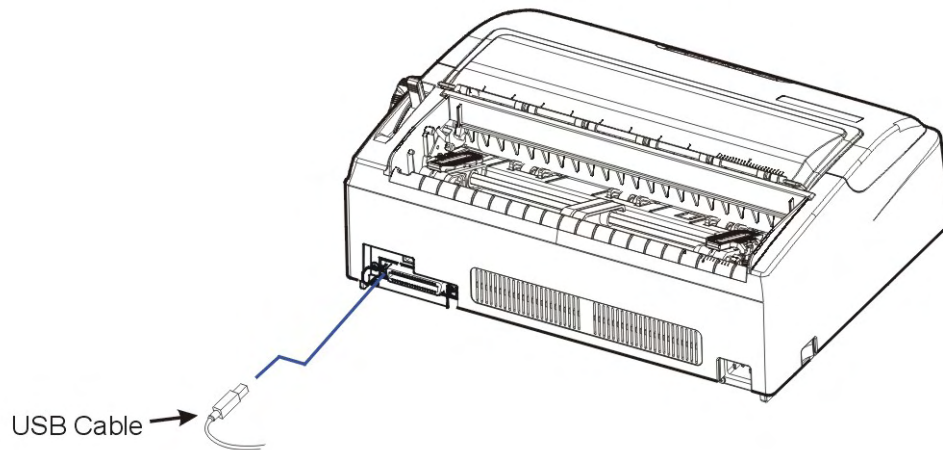

i The printer may also be purchased with an additional interface. The additional interface can be one of the followings: **Parallel, Serial, Ethernet, WIFI or Bluetooth.**

2.4 Connecting the Power Supply

Checking the printer voltage

Make sure that the device has been set according to your country's power supply voltage. To do this, check the rating plate at the back of the printer. Contact your dealer if the setting is incorrect.

i Never switch on the printer if the voltage setting is incorrect; This may result in electrical damage to the printer.

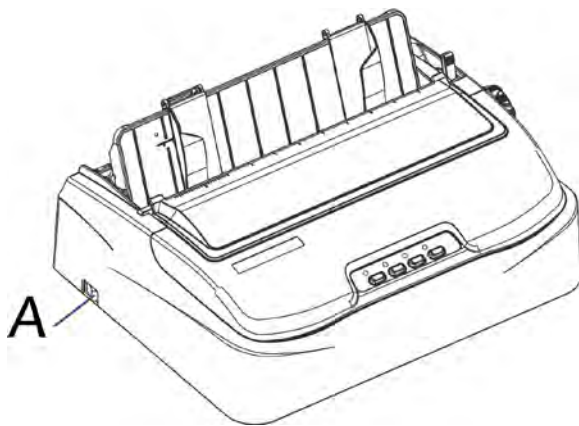

Make sure that the power switch "A", located to the left side of the printer, is in the "O" (off) position.

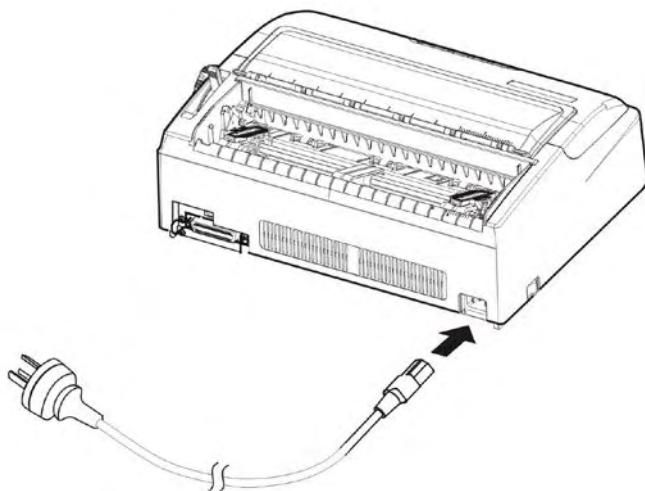

Connect the power cord to the power inlet of the printer. Connect the power cord plug to a mains socket. Switch on the printer.

2.5 Installing the Windows Driver

(Windows 2000 / XP / Vista / 7 / 8 / 8.1 and 2003 / 2008 / 2012 / 2012R2 Server)

1. Your printer CDROM comes with Windows drivers. Go to the Drivers folder and run the Installer "DriverSetup.exe". You will see the screen on the right. Select language, and click "Next" to continue.

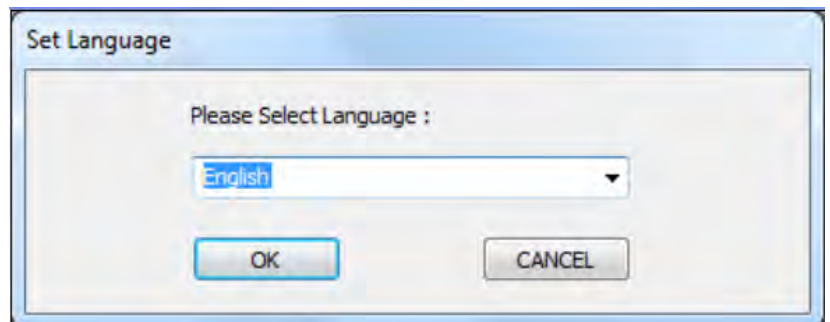

2. A picture shown on the right side appears. Click "Next" to continue.



Tally Dascom 1140

3. As shown in the picture on the right side, click “OK” to select automatic installation and click “Cancel” to select manual installation.

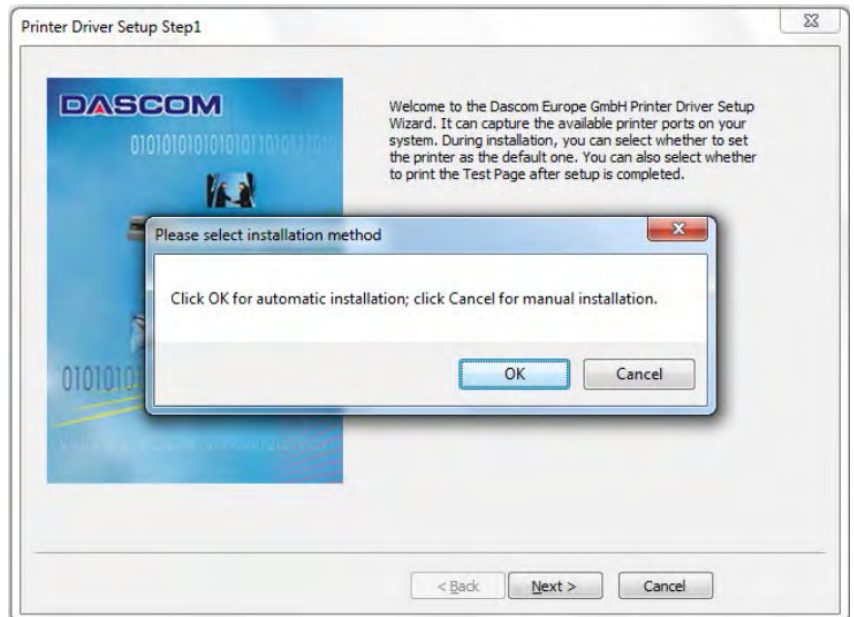

i If you have selected automatic installation in the third step, please refer to following three steps:

1) If you want to select automatic installation, make sure that the printer is connected with USB cable and power on. If the printer is not connected with USB cable or power off, a prompt on right side will appear if you select automatic installation. Click “OK” to select manual installation and click “Cancel” to cancel installation.

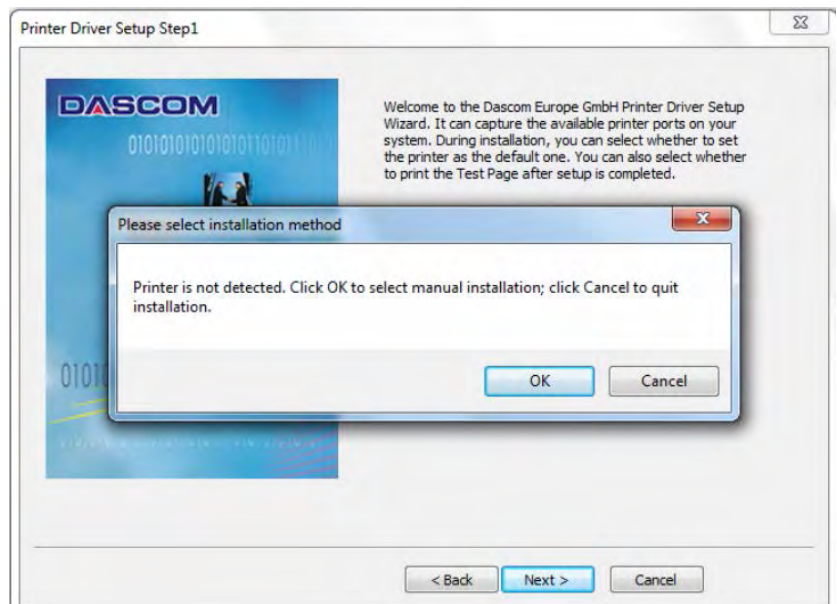

Tally Dascom 1140

2) If automatic installation is selected and the printer is connected with USB cable and power on, the printer model will be detected automatically. As shown in picture on the right side, click "Next" to continue.

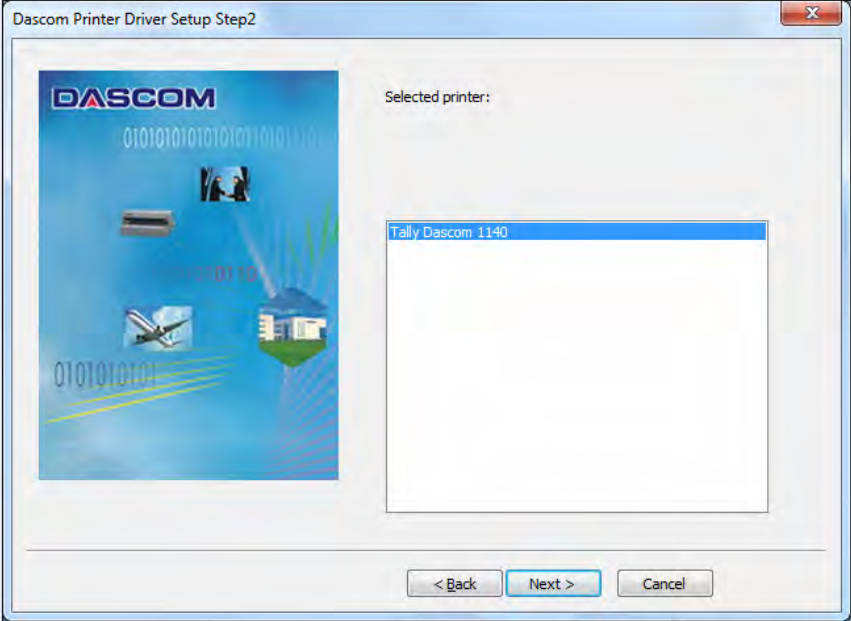

3) As shown in picture on right the side, USB port will be detected automatically. Click "Next" to continue.

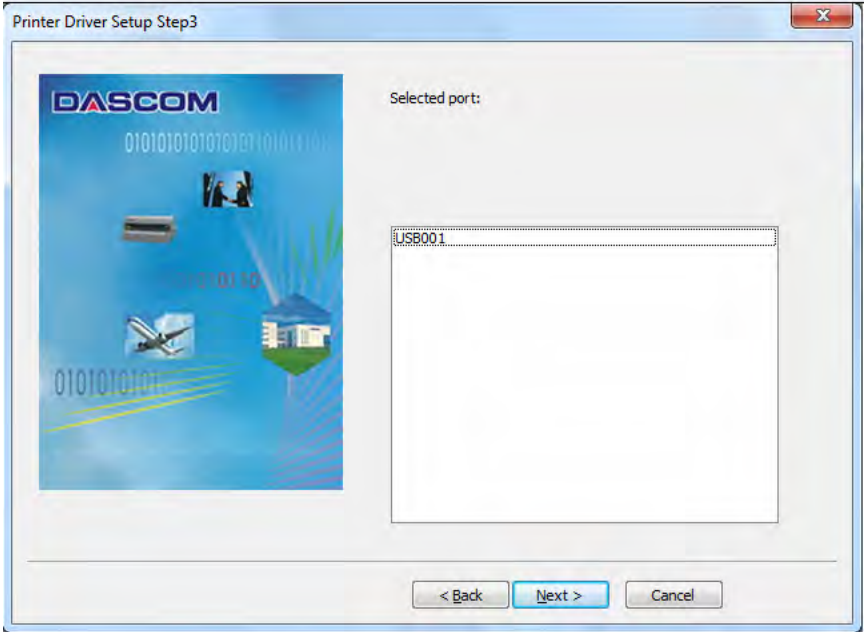

Tally Dascom 1140

i If you have selected manual installation in the third step, please refer to following two steps:

1) If manual installation is selected, picture on right side will appear after you click "Cancel". Select the desired printer model and click "Next" to continue.

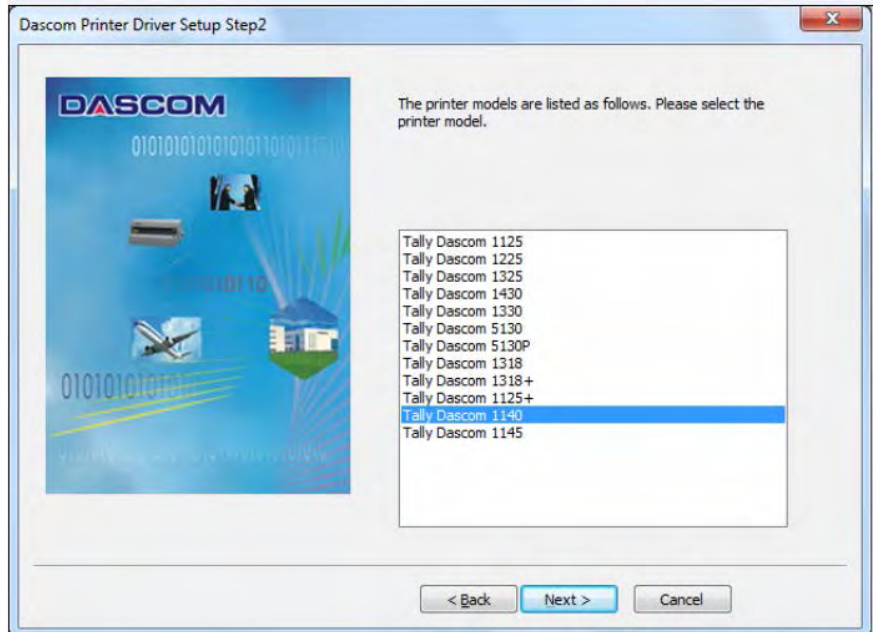

2) Picture on the right side will appear after you click "Next". Select installation port and click "Next" to continue.

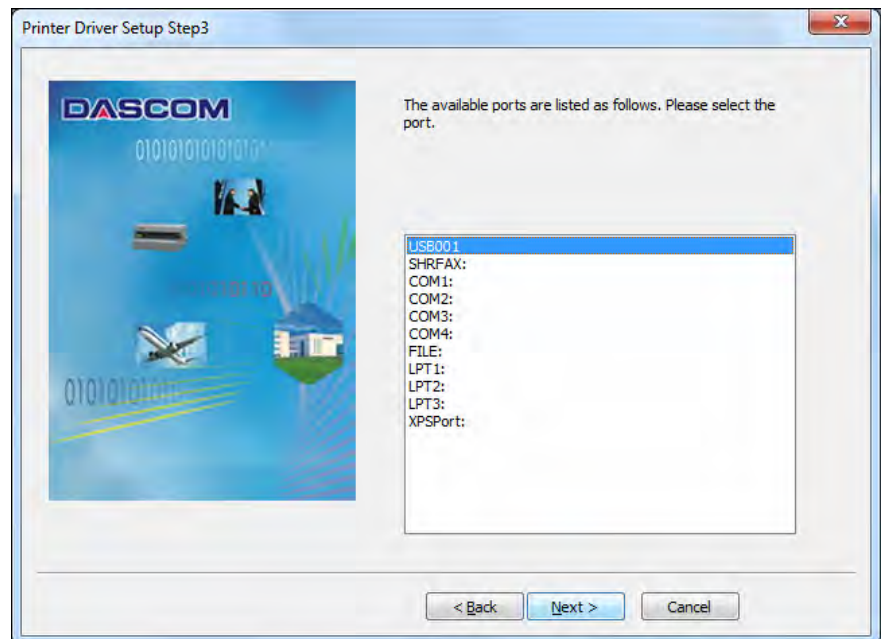

Tally Dascom 1140

4. Here you can choose whether to set the driver as the system default driver, and whether you want to print the Test Page after installation is completed. Click “Next” to continue.

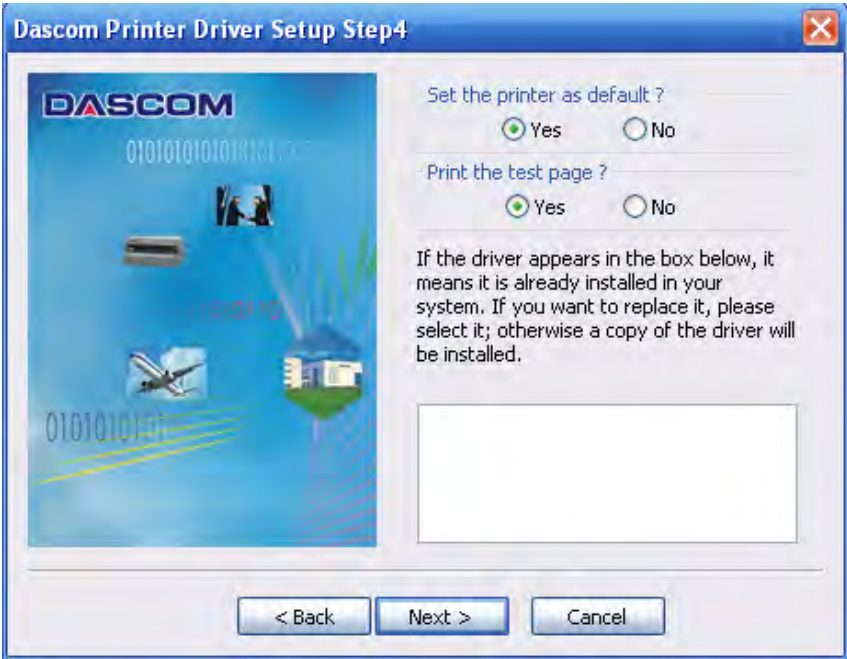

5. As shown in the picture on right side, click “Finish”.

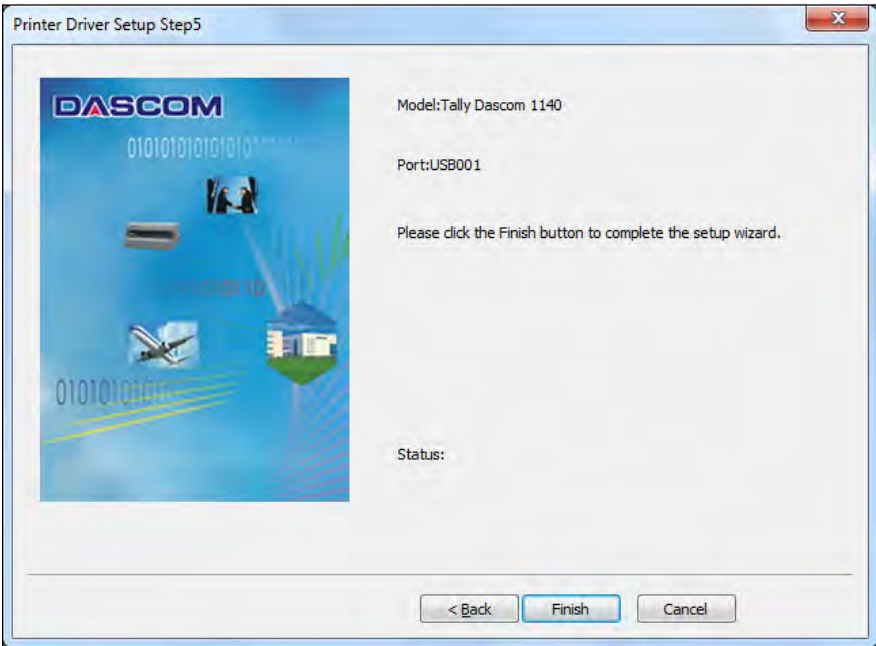

i For XP system, the following situation may appear after you click “Finish” in above step:

1) If the driver is not yet Microsoft Certified, the message on the right would appear. Click “Continue Anyway”. (As we continue to expand our product portfolio, not all of our drivers may be certified yet. Please check our website www.dascom.com for the latest certified drivers.)

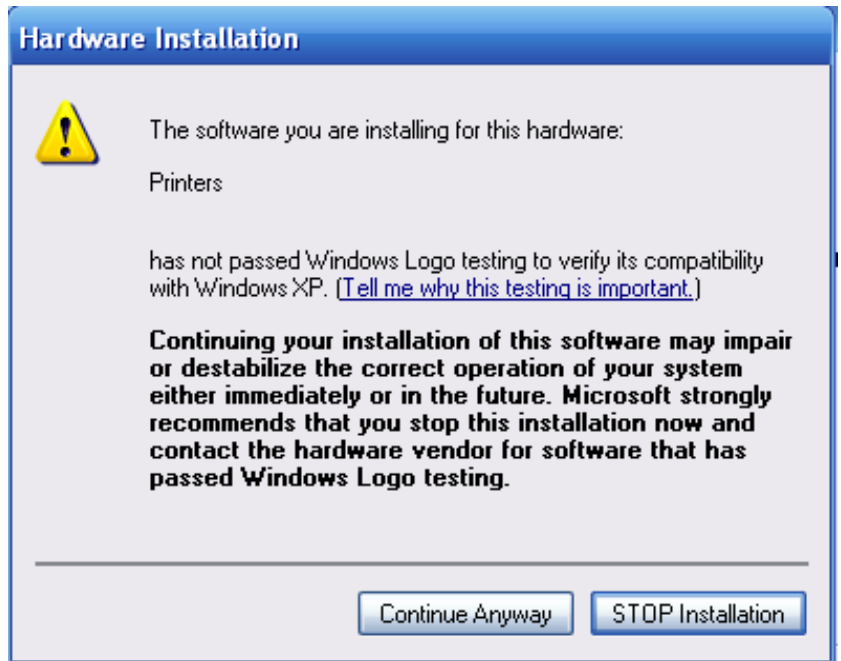

2) Installation in progress.

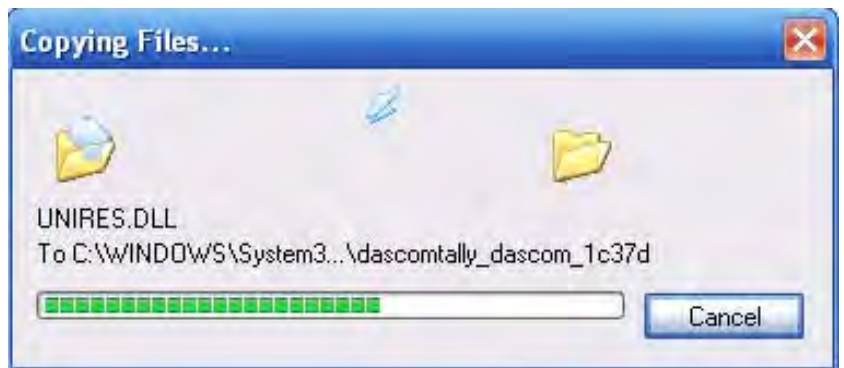

6. After installation is completed successfully, you will see the message on the right.

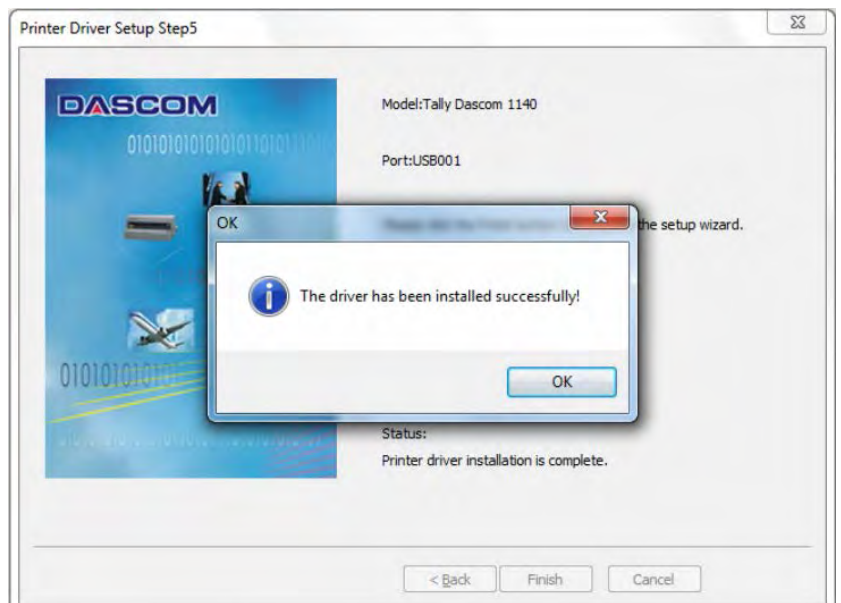

3 Paper Installation Guide

The printer can handle either single sheets or continuous forms. Single sheets, also called cut sheets, include envelopes and non-continuous, multipart forms. Continuous forms include labels and multipart forms fed into the printer using the forms tractors. The printer is able to print 1~5 plies multipart paper.

i Remove any paper clip or staple. Do not load paper that has been folded or damaged, wrinkled, or curled.

3.1 Adjusting the Print Gap Lever

The print gap lever is on the left side of the printer inside the top cover. Take care to adjust the print gap lever to a suitable position whenever you change the number of copies being printed. Using the wrong print gap may cause print head damage or paper jams.

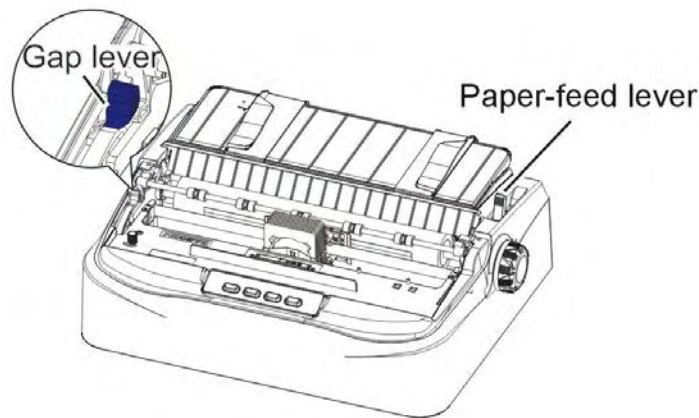

Paper type	Weight (g/m ²) / ply	Thickness (mm)	Gap lever position
Single sheet	52~100	0.06~0.12	1P~2P
3-ply	40~52	0.12~0.14	3P~4P
4-ply	40~52	0.17~0.22	4P~5P
5-ply	40~52	0.23~0.27	5P
Change ribbon	---	Above 0.58	RIBBON

There are 2 paper feed modes: friction feed and tractor feed.

3.2 Friction Feed Handling

1. Raise the single sheet feeder until it locks into its mounting.
2. Move the paper-feed lever forward to “” for friction feed mode. Make sure that no paper is in the printer when you switch the paper path.
3. Adjust the print gap lever if necessary.
4. Align the left paper guide with the mark on the left of the single sheet feeder.
5. Adjust the right paper guide to the width of the paper used.

6. Insert a sheet of paper. Make sure that the bottom edge of the paper engages snugly with the platen. Please push the paper in manually if the paper does not feed in while the friction roller is running.
7. The paper should advance automatically to the print position. The printer is now ready to print in the online state.

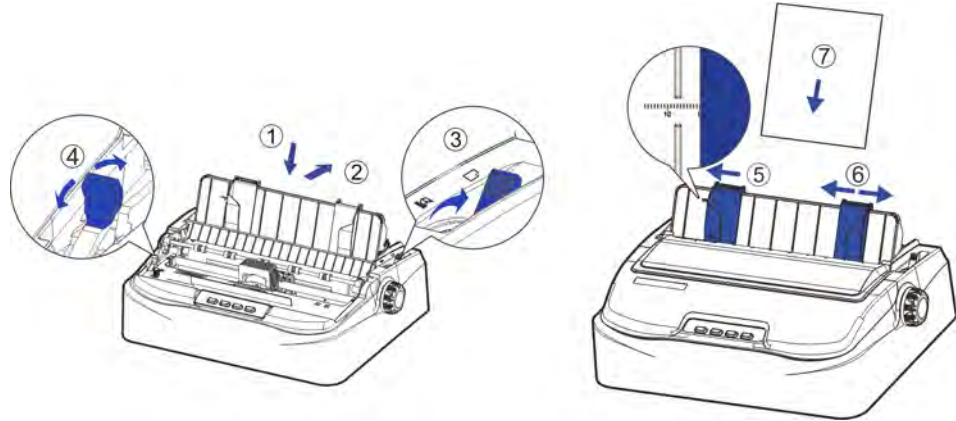

3.3 Tractor Feed Handling

1. Move the paper-feed lever backward to “” for continuous paper position.
2. Adjust the print gap lever if necessary.
3. Raise the tractor doors and fit the first 3 paper holes onto the left tractor pins. Close the left tractor door. In the same way, install the paper on the right tractor.
4. Adjust the right tractor to the width of the paper until the paper is flat. Do not stretch the paper too taut. Push the right lock lever down to secure the right tractor in place.
5. Press the **【Load/Eject】** key to load the paper to the starting print position. The printer is now ready to print in the online state.

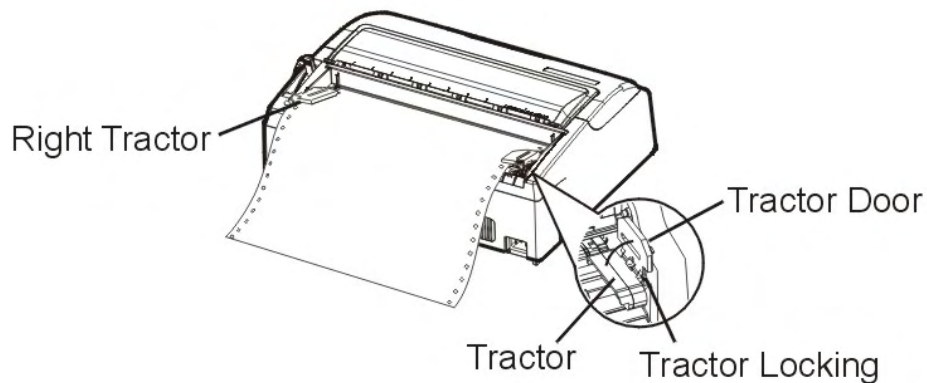

3.4 Continuous Paper Placement

1. Place the printer on a solid base. The minimum suitable height of the solid base is 75 cm.
2. Left and right positioning: The direction of continuous paper should be parallel with the paper guide. The tolerance should be less than 3 cm.

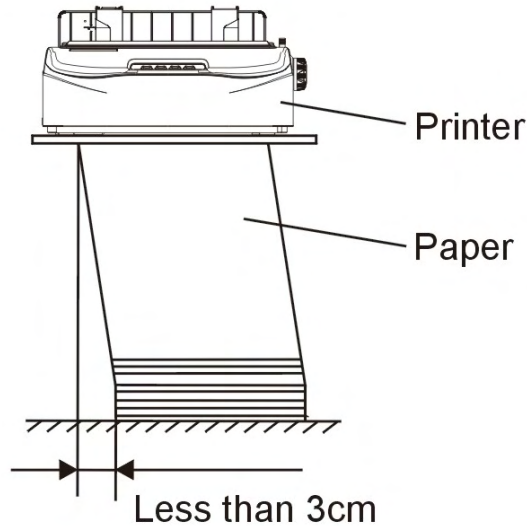

3. Front and back positioning: The distance between the rear of printer and the wall should be more than 60cm. To avoid paper jam, the distance between the continuous paper and the edge of desk should be 10~15 cm.

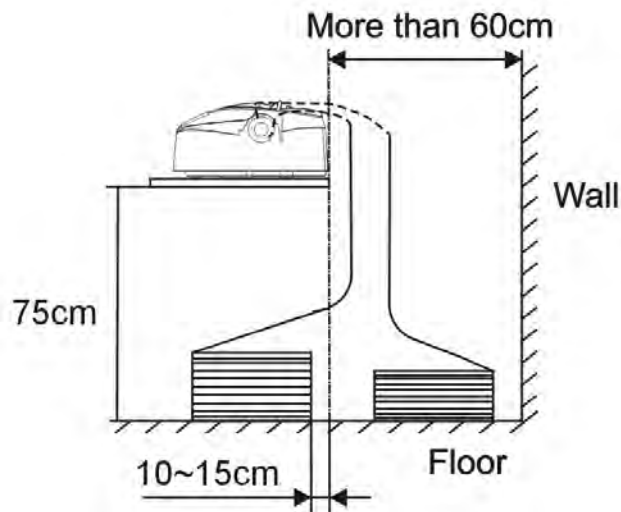

4 Control Panel Operation

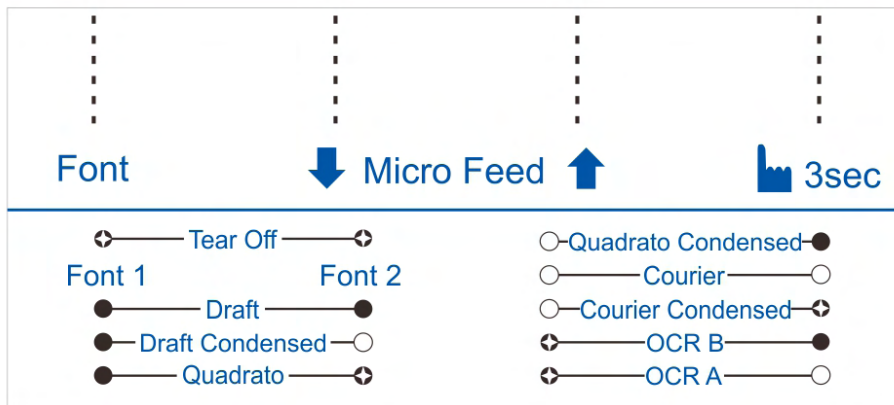
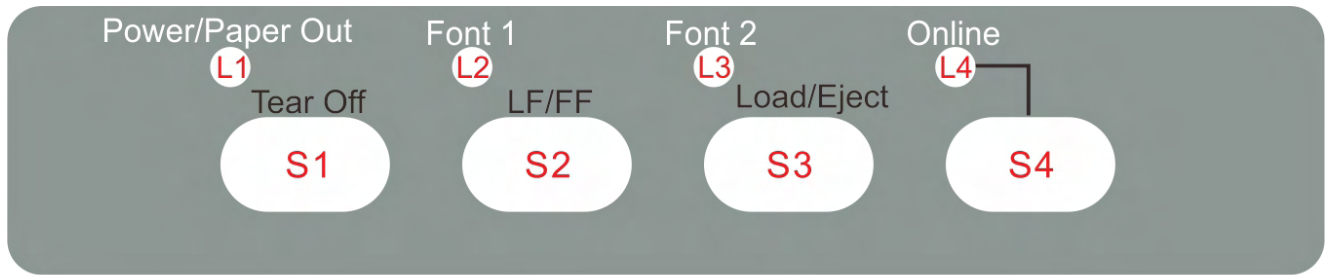

Note: A black filled circle means LED off; A white circle means LED on.

There are 4 switches S1~S4 and 4 LEDs L1~L4. The meaning and application of each switch and LED are described below:

4.1 LED Indicators

“Power/Paper Out” LED:

On: Power on

Flashing: Paper out

Flashing + buzzer: Paper jam

“Font 1 and Font 2” LED:

Flashing together: Indicates continuous paper is at tear-off position; otherwise it indicates the selected font. See table 4.1.

“Online” LED:

On: The printer is in online state and ready to receive data from the computer.

Off: The printer is in offline state and cannot receive data.

Tally Dascom 1140

4.2 Control Panel Keys

“Tear Off” Key:

When online, this key will move any loaded continuous paper to the tear-off position. When in setup state, this key is used to select the desired font.

“LF/FF” Key:

Pressing this key will feed paper one line forward. By holding down this key, the printer will initially feed a few lines, then perform a form feed (continuous paper mode) or eject the form (single sheet mode).

“Load/Eject” Key:

When paper is loaded, pressing this key will eject the paper (single sheet mode) or park the paper (continuous paper mode). When paper is not loaded, pressing this key will load the paper to the starting print position.

“Online” Key:

This key switches the printer between online and offline states. Printing is stopped when the printer is switched to offline state. When printer is switched to online state again, printing will resume.

Table 4.1

Font Selection Label	L2 State	L3 State
Tear Off	Blink	Blink
Draft	Off	Off
Draft Condensed	Off	On
Quadrato	Off	Blink
Quadrato Condensed	On	Off
Courier	On	On
Courier Condensed	On	Blink
OCR B	Blink	Off
OCR A	Blink	On

Table 4.2

Switch	Label
S1	Tear off
S2	LF/FF
S3	Load/Eject
S4	Online

Table 4.3

LED	Function
L1	Power/Paper Out
L2	Font1
L3	Font2
L4	Online

4.3 Panel Operation

There are 3 states of operation: Online, Setup and Power On.

In the Online state, the keys provide the following functions: Go to Tear Off position, Line Feed/Form Feed, Load/Eject, Clear Buffer and switch to offline state for accessing to Setup state.

In the Setup state, the keys provide font selection, and micro feed paper.

To enter the Power On state, the user holds down a key or a combination of keys while powering up the printer. This state provides the following functions: Hex-dump, Main Menu setup, print Main Menu, Customize Form, restore factory defaults, and firmware update.

The followings describe the 3 states in details.

Legend:

[A] = press and hold switch A

{B} = press and then release switch B

[A]+ {B} = press switch B while holding A

4.4 Online State

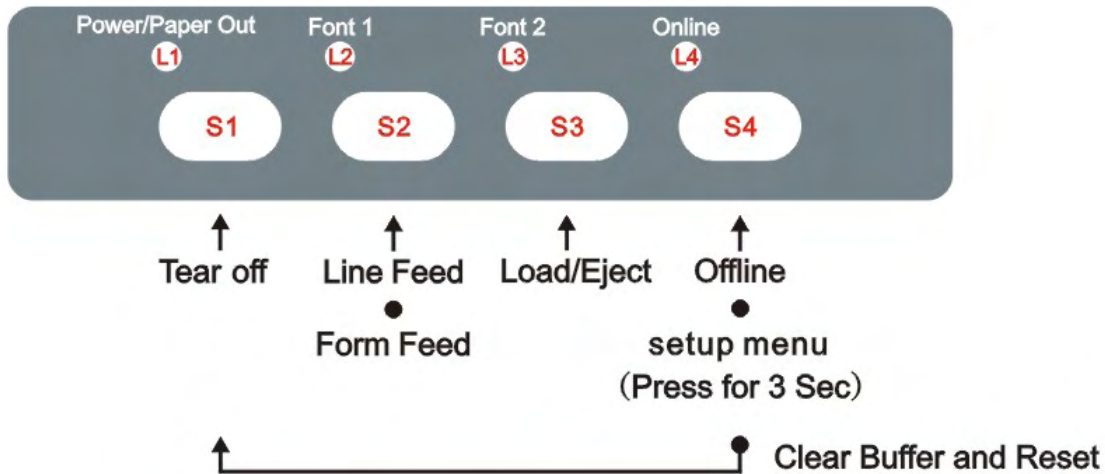

Remark : ● Hold ↑ Press

Function Name	Switch Operation	LED	Function Description
Tear Off	{S1}	L2, L3 flash	This is valid for tractor mode only. It feeds the form to the tear-off position. After tearing off the form, printing starts on the next TOF by pressing any key or receiving print data from the host.
LF	{S2}	-	Feeds one line with every press of S2
FF	[S2]	-	Pressing this key will feed paper one line forward. By holding down this key, the printer will initially feed a few lines, then perform a form feed (continuous paper mode) or eject the form (single sheet mode).
Load/Eject	{S3}	-	<ul style="list-style-type: none"> ● Load: Automatically loads the paper (according to path selection) when no paper is on the platen. ● Eject: For rear tractor, it retracts the form from the platen to allow users to install cut sheets. (NOTE: Users have to toggle the path selection lever.) For cut sheets, it ejects the form on the platen.
Online	{S4}	L4	Toggles between Online and Offline states.
Setup State	[S4]	L4	Hold the S4 key for 3 seconds. Toggles to 3s Setup state. Indicated by flashing L4.
Clear Buffer and Reset	[S4]+{S1}	--	<ul style="list-style-type: none"> ● Clears the print buffer. Beeps once upon completion. ● Pressing S1 longer initializes the printer to default settings. Beeps 3 times upon completion.

4.5 Setup State

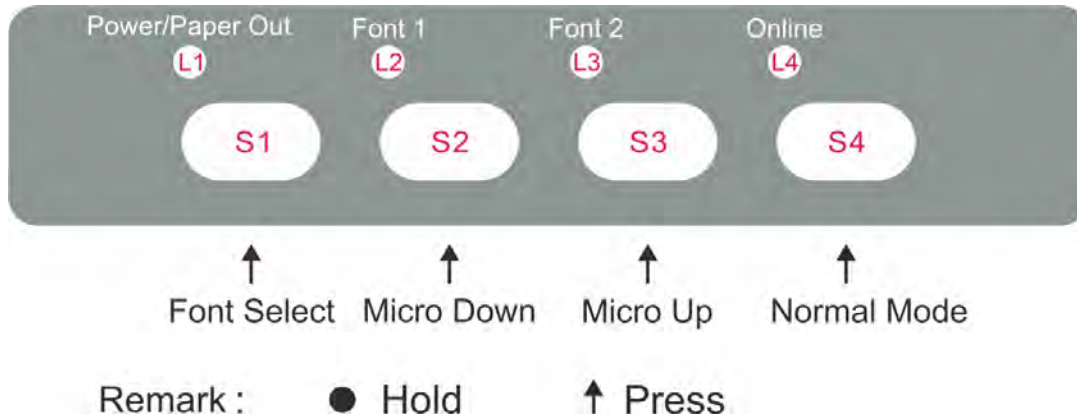

Function Name	Switch Operation	LED	Function Description
Online state	{S4}	L4	Toggling to the Online state will cause the printer to go into a ready-to-print state. Any changes made in Setup state will be saved permanently. Lighting up L4 indicates the Online state.
Micro UP	{S3}	--	Press S3 to micro feed paper up.
Micro Down	{S2}	--	Press S2 to micro feed paper down.
Font Select	{S1}	L2, L3	Refer to Table 4.1 for details.

4.6 Power-On State

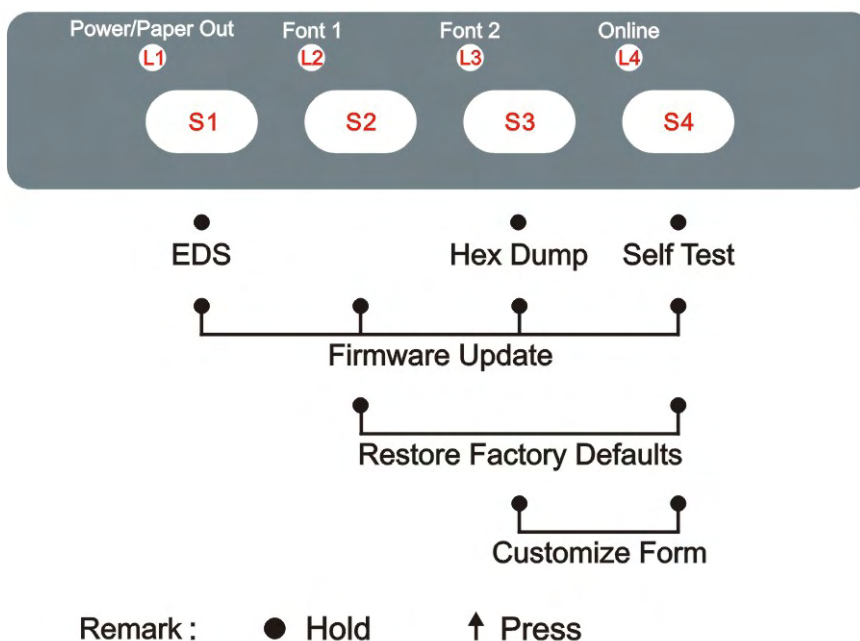

Tally Dascom 1140

Function Name	Switch Operation	LED	Function Description
Hex Dump	[S3]	-	<p>Beeps once to indicate going into hex dump mode:</p> <ul style="list-style-type: none"> Prints data from host in hexadecimal representation. Pressing S4 suspends the printing. When the hex dump has finished, pressing S4 forces the printing of the last line of data, as any line termination control code from host has no function. Switch off the power to terminate the hex dump.
Menu Setup / EDS	[S1]	-	Allows for Main Menu setting changes. Please read the instructions printed on how to change settings when this mode is activated. (EDS: Electronic DIP Switch)
Self Test / Status Page	[S4]	-	Prints the printer settings and self-test pattern.
Firmware Update	[S1]+[S2]+[S3] + [S4]	L3, L4	<ul style="list-style-type: none"> Alternate flashing of L3 and L4 indicates ready for firmware update from host. When new firmware is being received: L3 and L4 flash together, while L1 and L2 LEDs are constantly on. <p>When downloading is completed, the carriage returns to home position. Printer initializes normally.</p>
Restore Factory Defaults	[S2] + [S4]	-	Restore all settings to factory defaults. The carriage initializes and the printer beeps once after restoration.
Customize Form	[S3] + [S4]		To customize the margins and tear-off position, please refer Chapter 6 for details.

5 Printer Setting Changes

In order to meet specific print requirements, the printer configurations may be changed as follows: Hold down the Load/Eject key while powering on the printer and then release the key when the print head starts to move. The printer will enter Main Menu setup state. Follow the instructions printed on how to make setting changes. When a new setting is saved, it is retained after the printer has been powered off.

The Printer Settings menu contains 8 sub-menus: System Setup, Paper Setup, Interface Setup, Character Setup, Other Setup, Bi-directional Alignment, BlackMark Mode, Restore Factory Defaults.

5.1 System Setup

System setup	Valid Settings	Function
Language	English , Deutsch, Россия, Italiano, Français, Español, Türkçe, Português	Allows user to select one of the following languages: English, German, Russian, Italian, French, Spanish and Turkish, Portuguese
Emulation	ESC/P2 , IBM 2380+	Selects the printer emulation. This should be the same as the host printer driver.
Auto CR (ESC/P2)	No, Yes	Yes: LF = LF+CR; No: LF = LF (Applies to ESC/P2 emulation only)
Auto CR(IBM)	No , Yes	Yes: LF = LF+CR; No: LF = LF (Applies to IBM emulation only)
Auto LF	No , Yes	Yes: CR = CR+LF; No: CR = CR
Print Dir	Bi-Dir , Uni-Dir	Bi-Dir: Graphics and text are printed in both directions, resulting in faster printing speed. Uni-Dir: Graphics and text are printed from left to right, resulting in higher precision.
Zero	0 , Ø	0: No-slashed Zero 0. Ø: Slashed Zero Ø.
Graphic Speed	Normal , Fast	Selects different print quality and print speed for graphic.
Change Pin#1:	No , 1, 2, 3, 4, 5, 6, 7, 8, 9	Defines the first broken / worn out pin. This pin will be substituted by an adjacent pin in the second pass printing. No: Not to substitution of the worn out pin.
Change Pin #2	No , 1, 2, 3, 4, 5, 6, 7, 8, 9	Defines the first broken / worn out pin. This pin will be substituted by an adjacent pin in the second pass printing. No: No substitution.

Tally Dascom 1140

System setup	Valid Settings	Function
Power-Saving	OFF, 1min, 2min, 5min , 10min	Defines the idle period before the printer gets into Save-energy Mode. OFF: The printer never goes into Save-energy Mode.
Impact	Normal , Heavy	Normal: The print speed is faster causing head hot easily and the impact force is weaker. Heavy: The print speed is reduced, resulting better thermal performance and copy capability.

5.2 Paper Setup

Paper Setup	Valid Settings	Function
Single FormLen	2.5, 11/4, 3, 3.5, 11/3, 4, 5, 5.5, 6, 7, 8, 9, 10, 11 , 12, 14, A4, B4, Define	Sets the page length for single paper
Single Top	0, 1/6, 1/4, 1/3 , 1/2, 2/3, 3/4, 1, Define	Defines the separation in inches from the top edge of a single paper to the first print line.
Single Bottom	0 , 1/6, 1/4, 1/3, 1/2, 2/3, 3/4, 1, Define	Defines the separation in inches from the bottom edge of a single paper to the last print line.
Single Left Mrg (1.00mm)	-7, -6, -5, -4, -3, -2, -1, 0 , 1, 2, 3, 4, 5, 6, 7, Define	Compensation value added to Single Left Mrg.
Single Top Mrg (0.01")	-7, -6, -5, -4, -3, -2, -1, 0 , 1, 2, 3, 4, 5, 6, 7	Compensation value added to Single Top.
Auto Load	Disable, 0.5sec , 1sec, 1.5sec, 2sec	Defines the settling time before a single sheet is loaded. Disable: Press the 【 Load/Eject 】 key manually to load a single sheet.
Fanfold FormLen	2.5, 11/4, 3, 3.5, 11/3, 4, 5, 5.5, 6, 7, 8, 9, 10, 11 , 12, 14, A4, B4, Define	Sets the Page Length for fanfold.
Fanfold Top	0, 1/6, 1/4, 1/3 , 1/2, 2/3, 3/4, 1, Define	Defines the separation in inches from the top edge of a fanfold to the first print line.
Fanfold Bottom	0 , 1/6, 1/4, 1/3, 1/2, 2/3, 3/4, 1, Define	Define the separation in inches from the bottom edge of a fanfold to the last print line.
Fanfold Left Mrg (1.00mm)	-7, -6, -5, -4, -3, -2, -1, 0 , 1, 2, 3, 4, 5, 6, 7, Define	Compensation value added to Fanfold Left Mrg.
Fanfold Top Mrg	-7, -6, -5, -4, -3, -2,	Compensation value added to Fanfold Top.

Tally Dascom 1140

Paper Setup	Valid Settings	Function
(0.01")	-1, 0 , 1, 2, 3, 4, 5, 6, 7	
Skip	No , Yes	<p>Skips printing on perforation area.</p> <p>Only valid to fanfold.</p> <p>Yes: Blank lines between 2 pages.</p> <p>No: No blank lines between 2 pages.</p>
Tear	Auto , Manual, View, Auto @ FF	<p>Auto: No incoming print data in 1~2 seconds after printing completed, the printer advances the form to the tear-off position. When the printer receives new print data, the form is ejected to the top-of-form.</p> <p>Manual: After the completion of a print job, press a panel key to advance the paper to the tear-off position.</p> <p>View: No incoming print data in 1~2 seconds after printing completed causes the printer to advance the paper by 2 lines. Printing resumes 2 lines below the torn edge.</p> <p>Auto @FF: a form feed command is necessary to auto feed the form to tear position.</p>
Buzzer	No, Yes	<p>No: Buzzer does not sound if out of paper.</p> <p>Yes: Buzzer sounds if out of paper.</p>
APW (Auto Paper Width detection)	No , Yes	<p>Yes: Measures the width of the paper automatically after loading the paper.</p> <p>No: Disables page width measurement.</p> <p>NOTE:</p> <p>The printer is equipped with a page width sensor called "APW".</p> <p>If the sensor is defective, the "APW" setting will not appear in the menu; The 【Power】 LED blinks, 【Font 1】 and 【Font 2】 have no change, 【Online】 LED is off.</p>
BlackMark	No , Yes	<p>No: Disables black mark sensor.</p> <p>Yes: Enables black mark sensor.</p> <p>When "Yes" and online, pressing the Tear Off key advances the paper to the tear-off position.</p> <p>BlackMark commands: (also see section 5.6)</p> <ul style="list-style-type: none"> • 1D 0C: Feeds paper to the print position designated by the black mark. Advance the paper to the tear-off position after printing. • 1C 28 4C 03 00 42 m:

Tally Dascom 1140

Paper Setup	Valid Settings	Function
		<p>m = 0: feeds paper to the print position designated by the black mark.</p> <p>m = 1: feeds paper to the black mark tear-off position.</p>
Bail mode	Invalid, Standard, Special	<p>The pressure lever presses the paper against the print platen during printing, but it is released for paper loading.</p> <p>Invalid: If you uninstall the lever or want to disable the function, set this setting to "invalid".</p> <p>Standard: Release the lever for paper loading and lower the lever to press the paper against the platen during printing.</p> <p>Special: When the paper is in tear-off position, after the printer received printing data, the printer will judge whether tear-off was implemented first. If tear-off was implemented and printing position is in lever area, then the printer will press the lever; If tear-off was not implemented, the printer will not press the lever.</p>
Roll Paper	No , Yes	In friction mode, 【LF/FF】 will not eject the paper and feed to next page. (Assume roll paper)

5.3 Interface Setup

Interface setup	Valid Settings	Function
PnP	No, Yes	<p>No: Disables plug and play for USB</p> <p>Yes: Enables plug and play.</p>
USB ID	No , Yes	<p>No: Disables USB ID.</p> <p>Yes: Enables USB ID</p>

5.4 Character Setup

Character setup	Valid Settings	Function
Character Table	Italic, Graphic	Italic: Selects standard character sets. Please refer to UG for details. Graphic: Selects IBM character sets. Please refer to UG for details.
Character Group	Group 1, Group 2	The interpretation of ASCII codes between 0x80~0x9F: Group 1: as control codes. Group 1: as printable characters.
Int'l Char Set	USA , France, Germany, UK, DenmarkI, Sweden, Italy, SpainI, Japan, Norway, DenmarkII, Spain II, LatinAm, Denmark, China	International character set selections
Font	Draft ,DraftCond,Quadrato,QuadratoCond,Courier,CourierCond,OCR B,OCR A	Selects the font.
Pitch(cpi)	10 , 12, 15, 17, 20, PS	Controls the characters per inch setting.
Code Page	CP 437 , CP 737, CP 850, CP 851, CP 852, CP 857, CP 858, CP 860, CP 861, CP 863, CP 1252, CP 1253, CP 1254, 8859-1, 8859-1 (SAP), 8859-2, 8859-5, 8859-7, 8859-9, 8859-15, Kamenicky , Mazovia, 866 Bulgaria, CP 1250, CP 1251. BRASCII, Abicomp, CP 865, CP 866, CRO-ASCII	Code page selections
HS-Draft	No, Yes	Yes: Prints High Speed Draft when Draft font is selected.

5.5 Other Setup

Other setup	Valid Settings	Function
Form Length Ctrl	No, Yes	No: Form length commands are invalid in neither of the emulation. Yes: Form length commands are valid in either of the emulations.
PrintSpeed Ctrl	No, Yes	No: Print speed commands are invalid in neither of the emulation. Yes: Print speed commands are valid in either of the emulations.
Pitch Ctrl	No, Yes	No: Ignores CPI commands Yes: CPI commands are valid
Font Ctrl	No, Yes	No: Ignores font select commands Yes: font select commands are valid
Uni-Dir Ctrl	No , Yes	No: Uni-Direction print commands are invalid in neither of the emulation. Yes: Uni-Direction print commands are valid in either of the emulations.

5.5.1 German (Deutsch)

System Setup	Gültige Werte
Sprache	English , Deutsch, Россия, Italiano, Français, Español, Türkçe, Português
Emulation	ESC/P2 , IBM 2380+
Auto CR (ESC/P2)	Nein, Ja
Auto CR (IBM)	Nein, Ja
Auto LF	Nein , Ja
Druck Dir	Bi-Dir , Uni-Dir
Null	0 , Ø
Graphikgeschw.	Normal , Schnell
Ersetze 1.Nadel	No , 1, 2, 3, 4, 5, 6, 7, 8, 9
Ersetze 2.Nadel	No , 1, 2, 3, 4, 5, 6, 7, 8, 9
Impact Mode	Normal , Stark

Tally Dascom 1140

Papier Setup	Gültige Werte
Einzel Länge	2.5, 11/4, 3, 3.5, 11/3, 4, 5, 5.5, 6, 7, 8, 9, 10, 11 , 12, 14, A4, B4, Definiert
Einzel Ob Rand	0, 1/6 , 1/4, 1/3, 1/2, 2/3, 3/4, 1, Definiert
Einzel Unt Rand	0, 1/6, 1/4, 1/3, 1/2, 2/3, 3/4, 1, Definiert
Einzel Li Rand	-7, -6, -5, -4, -3, -2, -1, 0 , 1, 2, 3, 4, 5, 6, 7, Definiert
Einzel Ob Rand Fein	-7, -6, -5, -4, -3, -2, -1, 0 , 1, 2, 3, 4, 5, 6, 7
Auto Laden	Ungültig, 0.5sec , 1sec, 1.5sec, 2sec
Endlos Form Länge	2.5, 11/4, 3, 3.5, 11/3, 4, 5, 5.5, 6, 7, 8, 9, 10, 11 , 12, 14, A4, B4, Definiert
Endlos Ob Rand	0, 1/6 , 1/4, 1/3, 1/2, 2/3, 3/4, 1, Definiert
Endlos Unt Rand	0 , 1/6, 1/4, 1/3, 1/2, 2/3, 3/4, 1, Definiert
Endlos Li Rand	-7, -6, -5, -4, -3, -2, -1, 0 , 1, 2, 3, 4, 5, 6, 7, Definiert
Endlos Ob Rand Fein	-7, -6, -5, -4, -3, -2, -1, 0 , 1, 2, 3, 4, 5, 6, 7
Perforationssprung	Nein , Ja
Abreißen	Auto , Manuell, Kurz, Auto@FF
Summer	Nein, Ja
Black Mark	Nein , Ja
Andruckbügelmodus	Ungültig, Standard , Spezial

Schnittstellen Setup	Gültige Werte
PnP	Nein, Ja
USB ID	Nein , Ja

Zeichen Setup	Gültige Werte
Zeichentabelle	Italic, Graphik
PC-Zeichensatz	Gruppe 1, Gruppe 2
Land	USA , Frankreich, Deutschland, UK, Dänemark I, Schweden, Italien, Spanien I, Japan, Norway, Dänemark II, Spanien II, Lat-Amerika, Dänemark/Norwegen, China
Font	Draft , DraftCond, Quadrato, QuadratoCond, Courier, CourierCond, OCR B, OCR A
Laufweite(cpi)	10 , 12, 15, 17, 20, PS
Zeichensatz	CP 437 , CP 737...
HS-Draft	Nein, Ja
Formularlänge Strg	Nein, Ja
Geschwindigkeit Strg	Nein, Ja
Laufweite Strg	Nein, Ja
Font Strg	Nein, Ja

Tally Dascom 1140

Uni-dir Strg	Nein , Ja
Erweitertes Setup	Gültige Werte
Formularlänge Strg	Nein, Ja
Geschwindigkeit Strg	Nein, Ja
Laufweite Strg	Nein, Ja
Font Strg	Nein, Ja
Uni-dir Strg	Nein , Ja

5.5.2 Russian (Россия)

обновление системы	Правильные значения
Язык	English , Deutsch, Россия, Italiano, Français, Español, Türkçe, Português
Эмуляция	ESC/P2 , IBM 2380+
Авто CR(ESC/P2)	Нет, Да ,
Авто CR (IBM)	Нет, Да ,
Авто LF	Нет , Да
направление печати	Однонаправ , Двухнаправ
Ноль	0 , Ø
Скнпнсть оечатк	Нормально , быстро
Замена 1.иглы	№ , 1, 2, 3, 4, 5, 6, 7, 8, 9
Замена 2 иглы	№ , 1, 2, 3, 4, 5, 6, 7, 8, 9
воздействия	Нормально , сильно

Настройка бумаги	Правильные значения
Длина отдельн. листов	2.5, 11/4, 3, 3.5, 11/3, 4, 5, 5.5, 6, 7, 8, 9, 10, 11 , 12, 14, A4, B4, определен
Верх. поле отд. лист	0, 1/6 , 1/4, 1/3, 1/2, 2/3, 3/4, 1, определен
нижн. поле отд. лист	0 , 1/6, 1/4, 1/3, 1/2, 2/3, 3/4, 1, определен
Слева отступ лист	-7, -6, -5, -4, -3, -2, -1, 0 , 1, 2, 3, 4, 5, 6, 7, определен
Верх отс. л. тонко	-7, -6, -5, -4, -3, -2, -1, 0 , 1, 2, 3, 4, 5, 6, 7
Автозагрузка	недейств, 0.5sec , 1sec, 1.5sec, 2sec
Длина непрер. бумаги	2.5, 11/4, 3, 3.5, 11/3, 4, 5, 5.5, 6, 7, 8, 9, 10, 11 , 12, 14, A4, B4, определен
Верх. поле непр. бум	0, 1/6 , 1/4, 1/3, 1/2, 2/3, 3/4, 1, определен
нижн. поле непр бум	0 , 1/6, 1/4, 1/3, 1/2, 2/3, 3/4, 1, определен
Слева отступ непрер	-7, -6, -5, -4, -3, -2, -1, 0 , 1, 2, 3, 4, 5, 6, 7, определен
Верх отс. тонко непр	-7, -6, -5, -4, -3, -2, -1, 0 , 1, 2, 3, 4, 5, 6, 7

Tally Dascom 1140

Пропуск перфорации	Нет , Да
Настройка бумаги	Правильные значения
Отрыв бумаги	Авто , ручной, короткий, Auto@FF
Звук	Нет, Да
черной метки	Нет , Да
Мод. прижимн. скоба	Недопустимо, Стандарт , Специально

Настройка интерфейс	Правильные значения
PnP	Нет, Да
USB ID	Нет , Да

Настройка символов	Правильные значения
Таблица знаков	Курсив, Графика
Группа символов	Группа I, группа II
Набор знаков	USA , France, Germany, UK, Дания-I, Sweden, Italy, Spain-I, Japan, Норвегия, Дания II, Spain II, Латинская Америка, Дания/Норвегия, Китай
шрифт	Draft , DraftCond, Quadrato, QuadratoCond, Courier, CourierCond, OCR B, OCR A
знаков/дюйм (срi)	10 , 12, 15, 17, 20, PS
Кодовая таблица	CP437 , CP737...
Высокая скорость	Нет, Да

Другие настройки	Правильные значения
длина формуляр Ctrl	Нет, Да
скорости Ctrl	Нет, Да
Шаг Ctrl	Нет, Да
Шрифт Ctrl	Нет, Да
однонаправленной Ctrl	Нет , Да

Tally Dascom 1140

5.5.3 Italian (Italiano)

Setup sistema	Impostazioni Valide
Linguaggio	English , Deutsch, Россия, Italiano, Français, Español, Türkçe, Português
Emulazione	ESC/P2 , IBM 2380+
Auto CR (ESC/P2)	No, Si
Auto CR (IBM)	No, Si
Auto LF	No , Si
Direz. Stampa	Bi-Dir , Uni-Dir
Zero	0 , Ø
Veloc. Grafica	Normale , Veloce
Primo ago rotto	No , 1, 2, 3, 4, 5, 6, 7, 8, 9
Secondo ago rotto	No , 1, 2, 3, 4, 5, 6, 7, 8, 9
Modo Impatto	Normale , Pesante

Imposta carta	Impostazioni Valide
Lunghezza Foglio	2.5, 11/4, 3, 3.5, 11/3, 4, 5, 5.5, 6, 7, 8, 9, 10, 11 , 12, 14, A4, B4, Definito
Margine Sup. Foglio	0, 1/6 , 1/4, 1/3, 1/2, 2/3, 3/4, 1, Definito
Margine Infer. Foglio	0 , 1/6, 1/4, 1/3, 1/2, 2/3, 3/4, 1, Definito
Regola foglio a SX	-7, -6, -5, -4, -3, -2, -1, 0 , 1, 2, 3, 4, 5, 6, 7, Definito
Regola Sup. Foglio	-7, -6, -5, -4, -3, -2, -1, 0 , 1, 2, 3, 4, 5, 6, 7
Autocaricamento	Non valid, 0.5sec , 1sec, 1.5sec, 2sec
Lungh. Mod. Continuo	2.5, 11/4, 3, 3.5, 11/3, 4, 5, 5.5, 6, 7, 8, 9, 10, 11 , 12, 14, A4, B4, Definito
Margine Superiore	0, 1/6 , 1/4, 1/3, 1/2, 2/3, 3/4, 1, Definito
Mar. Inf. Continuo	0 , 1/6, 1/4, 1/3, 1/2, 2/3, 3/4, 1, Definito
Regola a SX continuo	-7, -6, -5, -4, -3, -2, -1, 0 , 1, 2, 3, 4, 5, 6, 7, Definito
Regola Sup. continuo	-7, -6, -5, -4, -3, -2, -1, 0 , 1, 2, 3, 4, 5, 6, 7
Salto Perforazione	No , Si
Strappo	Auto STP , STP manuale, STP corto, Auto@FF
Cicalino	No, Si
Segno nero riferim	No , Si
Barra rullini	Non valido, Standard , Speciale

Setup IF	Impostazioni Valide
PnP	No, Si
ID USB	No , Si

Tally Dascom 1140

Imposta caratteri	Impostazioni Valide
Tabella Caratteri	Italico, Grafica
Gruppo Carattere	Groupo 1, Groupo 2
Set Carat. Int.	USA , Francia, Germania, Regno Unito, Danimarca I, Svezia, Italia, Spagna I, Giappone, Norvegia, Danimarca II, Spagna II, Sudamerica, Danimarca/Norvegia, Porcellana
Fonte	Draft , DraftCond, Quadrato, QuadratoCond, Courier, CourierCond, OCR B, OCR A
Spaziatura (cpi)	10 , 12, 15,17, 20,PS
Code Page	CP437 , CP737...
HS-Bozza	No, Si

Altri Setup	Impostazioni Valide
Comando lunghezza	No, Si
Comando velocità	No, Si
Comando Spaziatura	No, Si
Comando Fonte	No, Si
Comando stampa mono	No , Si

5.5.4 French (Français)

Réglage Système	Paramètres Valides
Language	English , Deutsch, Россия, Italiano, Français, Español, Türkçe, Português
Emulation	ESC/P2 , IBM 2380+
RC-Auto (ESC/P2)	Non, Oui
RC-Auto (IBM)	Non, Oui
SL-Auto	Non , Oui
Dir Impr	Bidir , Unidir
Zéro	0 , Ø
Vitesse graphiq.	Normal , Rapide
Changer aiguille 1	Non , 1, 2, 3, 4, 5, 6, 7, 8, 9
Changer aiguille 2	Non , 1, 2, 3, 4, 5, 6, 7, 8, 9
Mode Impact	Normal , Fort

Tally Dascom 1140

Réglage papier	Paramètres Valides
Feuille LongPage	2.5, 11/4, 3, 3.5, 11/3, 4, 5, 5.5, 6, 7, 8, 9, 10, 11 , 12, 14, A4, B4, Définie
Bord Sup. Feuille	0, 1/6 , 1/4, 1/3, 1/2, 2/3, 3/4, 1, Définie
Bord Inf. Feuille	0 , 1/6, 1/4, 1/3, 1/2, 2/3, 3/4, 1, Définie
Marge Gauche Feuille	-7, -6, -5, -4, -3, -2, -1, 0 , 1, 2, 3, 4, 5, 6, 7, Définie
Marge Haute Feuille	-7, -6, -5, -4, -3, -2, -1, 0 , 1, 2, 3, 4, 5, 6, 7
Chargem. Autom	Non, 0.5sec , 1sec, 1.5sec, 2sec
Listing Longpage	2.5, 11/4, 3, 3.5, 11/3, 4, 5, 5.5, 6, 7, 8, 9, 10, 11 , 12, 14, A4, B4, Définie
Listing Bord Sup.	0, 1/6 , 1/4, 1/3, 1/2, 2/3, 3/4, 1, Définie
Listing Bord infér	0 , 1/6, 1/4, 1/3, 1/2, 2/3, 3/4, 1, Définie
Listing Marge Gauche	-7, -6, -5, -4, -3, -2, -1, 0 , 1, 2, 3, 4, 5, 6, 7, Définie
Listing Marge Haute	-7, -6, -5, -4, -3, -2, -1, 0 , 1, 2, 3, 4, 5, 6, 7
Saut perforation	Non , Oui,
Coupe	Auto , Manuelle, Courte, Auto@FF
Alarma	Non, Oui
Mode Repère Noir	Non , Oui
Mode entrainement	Non Valid, Standard , Spécial

Config Interface	Paramètres Valides
PnP	Non, Oui
USB ID	Non , Oui

Config. Caractère	Paramètres Valides
Table caractere	Italique, Graphique
Groupe Caractères	Groupe 1, Groupe 2
Pays	USA , France, Allemagne, Royaume-Uni, Denmark I, Suède, Italie, Espagne, Japon, Norvège, Denmark II, Espagne II, Ameriquelat, Denmark/Norvège, Chine
Police	Draft , DraftCond, Quadrato, QuadratoCond, Courier, CourierCond, OCR B, OCR A
Espacement (cpi)	10 , 12, 15, 17, 20, PS
Code Page	CP437 , CP737...
HS-Draft	Non, Oui

Tally Dascom 1140

Autre réglage	Paramètres Valides
Ctrl LongPage	Non, Oui
Ctrl Vitesse Impr.	Non, Oui
Ctrl Espacement	Non, Oui
Ctrl Fonte	Non, Oui
Ctrl Impr. Uni-Dir	Non , Oui

5.5.5 Spanish (Español)

Config. Sistema	Ajustes validos
Language	English , Deutsch, Россия, Italiano, Français, Español, Türkçe, Português
Emulación	ESC/P2 , IBM 2380+
Auto CR (ESC/P2)	No, Si
Auto CR (IBM)	No, Si
Auto LF	No , Si
ModoImpresión	Bi-Dir , Uni-Dir
Cero con barra	0 , Ø
Imp. Grafica	Normal , Rápido
Sust. 1er pin roto	Non , 1, 2, 3, 4, 5, 6, 7, 8, 9
Sust. 2do pin roto	Non , 1, 2, 3, 4, 5, 6, 7, 8, 9
Modo de Impacto	Normal , Fuerte

Config. Papel	Ajustes validos
Tam. Hojas Sueltas	2.5, 11/4, 3, 3.5, 11/3, 4, 5, 5.5, 6, 7, 8, 9, 10, 11 , 12, 14, A4, B4, Definido
Margen Sup. Hoja S.	0, 1/6 , 1/4, 1/3, 1/2, 2/3, 3/4, 1, Definido
Margen Inf. Hoja S.	0 , 1/6, 1/4, 1/3, 1/2, 2/3, 3/4, 1, Definido
Marg. Izq. Hoja S.	-7, -6, -5, -4, -3, -2, -1, 0 , 1, 2, 3, 4, 5, 6, 7, Definido
Marg. Sup. Hoja S.	-7, -6, -5, -4, -3, -2, -1, 0 , 1, 2, 3, 4, 5, 6, 7
Auto Carga	Inválido, 0.5sec , 1sec, 1.5sec, 2sec
Tam. Papel Continuo	2.5, 11/4, 3, 3.5, 11/3, 4, 5, 5.5, 6, 7, 8, 9, 10, 11 , 12, 14, A4, B4, Definido
Mar. Sup. Pap. Con	0, 1/6 , 1/4, 1/3, 1/2, 2/3, 3/4, 1, Definido
Mar. Inf. Pap. Cont.	0 , 1/6, 1/4, 1/3, 1/2, 2/3, 3/4, 1, Definido
Marg. Iz. Pap. Cont.	-7, -6, -5, -4, -3, -2, -1, 0 , 1, 2, 3, 4, 5, 6, 7, Definido
Marg. Sup. Pap. Cont.	-7, -6, -5, -4, -3, -2, -1, 0 , 1, 2, 3, 4, 5, 6, 7
Salto perforación	No , Si
Corte	Automático , Manual, Corto, Auto@FF
Alarma	No, Si

Tally Dascom 1140

Config. Papel	Ajustes validos
Modo Marca Negra	No , Si
Modo de barra de presión	Inválido, Estándar , Especial

Conf. Interface	Ajustes validos
PnP	No, Si
ID USB	No , Si

Config. Carácter	Ajustes validos
Tabla de Caracteres	Italic, Grafica
Grupo de Caracteres	Grupo 1, Grupo 2
Juego Carácter Int.	USA , Francia, Alemania, Reino Unido, Dinamarca I, Suecia, Italia, España, Japón, Noruega, Dinamarca II, España II, AméricaLat, Dinamarca, China
Tamaño Letra (cpi)	10 , 12, 15, 17, 20, PS
Fuente	Draft , DraftCond, Quadrato, QuadratoCond, Courier, CourierCond, OCR B, OCR A
Tabla Carácter	CP437 , CP737...
Alta Velocidad	No, Si

Config. Otros	Ajustes validos
Cmd. Long. de Hoja	No, Si
Cmd. Vel. Impresión	No, Si
Cmd. Tamaño Letra	No, Si
Cmd. Fuente	No, Si
Cmd. Imp. Uni-dir	No , Si

5.5.6 Turkish (Türkçe)

Sistem Ayarı	Geçerli ölçüler
Lisan	English , Deutsch, Россия, Italiano, Français, Español, Türkçe, Português
Emülasyon	ESC/P2 , IBM 2380+
Otom. Satırbaşı (ESC/P2)	Hayır, Evet
Otom. Satırbaşı (IBM)	Hayır, Evet
Otom. Satır besleme	Hayır , Evet
Yazdırma yönü	Yki-Yöne Tek-Yöne
Sıfır Sayısı	0 , Ø
Grafik Hızı	Normal , Hızlı
Arızalı 1. iğne yed	Hayır , 1, 2, 3, 4, 5, 6, 7, 8, 9
Arızalı 2. iğne yed	Hayır , 1, 2, 3, 4, 5, 6, 7, 8, 9
Vuruş modu	Normal , Güçlü

Kağıt Ayarı	Geçerli ölçüler
Tek kağıt uzunluğu	2.5, 11/4, 3, 3.5, 11/3, 4, 5, 5.5, 6, 7, 8, 9, 10, 11 , 12, 14, A4, B4, Oto.Tanım.
Tek-kağıt Üst boşluğu	0, 1/6 , 1/4, 1/3, 1/2, 2/3, 3/4, 1, Oto.Tanım.
Tek-kağıt Altkenar	0 , 1/6, 1/4, 1/3, 1/2, 2/3, 3/4, 1, Oto.Tanım.
Tek-kağıt Sol ayar	-7, -6, -5, -4, -3, -2, -1, 0, 1, 2, 3, 4, 5, 6, 7, Oto.Tanım.
Tek-kağıt Üst ayar	-7, -6, -5, -4, -3, -2, -1, 0 , 1, 2, 3, 4, 5, 6, 7
Otom. Yükleme	Geçersiz, 0.5sec , 1sec, 1.5sec, 2sec
Sürekli Kağıt Uzunluğu	2.5, 11/4, 3, 3.5, 11/3, 4, 5, 5.5, 6, 7, 8, 9, 10, 11 , 12, 14, A4, B4, Oto.Tanım.
Sürekli Üst Marj	0, 1/6 , 1/4, 1/3, 1/2, 2/3, 3/4, 1, Oto.Tanım.
Sür. Form Kğt Alt	0 , 1/6, 1/4, 1/3, 1/2, 2/3, 3/4, 1, Oto.Tanım.
Sür Form Kğt Sol	-7, -6, -5, -4, -3, -2, -1, 0 , 1, 2, 3, 4, 5, 6, 7, Oto.Tanım.
Sür Form Kğt Üst	-7, -6, -5, -4, -3, -2, -1, 0 , 1, 2, 3, 4, 5, 6, 7
Delik atlama	Hayır , Evet
Kağıt Kesme	Oto.kesim , Elle kesim, kısa kesim, Auto@FF
ikaz	Hayır, Evet
Siyah Çizgi algı	Hayır , Evet
basınç yay modu	Geçersiz, Standart , özel

Bağlantı Ayarı	Geçerli ölçüler
PnP	Hayır, Evet
USB ID	Hayır , Evet

Tally Dascom 1140

Karakter ayarı	Geçerli ölçüler
Karakter tablosu	İtalyan, Grafik
Karakter Grubu	Grup 1, Grup 2
Karakter setleri	Amerika , Fransa, Almanya, İngiltere, Danimarka I, İsveç, İtalya, İspanya, Japonya, Norveç, Danimarka II, İspanya II, Ltn Amerika, Danimarka, Çin
Yazı Karakteri	Draft , DraftCond, Quadrato, QuadratoCond, Courier, CourierCond, OCR B, OCR A
Karakter Sıklığı (dpi)	10 , 12, 15, 17, 20, PS
Kod Sayfası	CP437 , CP737..
Yük.Hız-Taslak	Hayır, Evet

Diğer Ayarlar	Geçerli ölçüler
Köt Uzunluk Komutu	Hayır, Evet
Baskı Hızı Komutu	Hayır, Evet
Karak. Aralık Kont.	Hayır, Evet
Yazı Tipi Komutu	Hayır, Evet
Tek yön bask Komutu	Hayır , Evet

5.5.7 Portuguese (Português)

Config. Sistema	Valores válidos
Linguagem	English , Deutsch, Россия, Italiano, Français, Español, Türkçe, Português
Emulação	ESC/P2 , IBM 2380+
Auto CR (ESC/P2)	Não, Sim
Auto CR (IBM)	Não, Sim
Auto LF	Não , Sim
Direção Imp.	Bi-Dir , Uni-Dir
Zero	0 , Ø
Imp. Grafica	Normal, Rápido
Substituição Pino 1	No , 1, 2, 3, 4, 5, 6, 7, 8, 9
Substituição Pino 2	No , 1, 2, 3, 4, 5, 6, 7, 8, 9
Modo de Impacto	Normal , Forte

Tally Dascom 1140

Config. Papel	Valores válidos
Tam. Folha Solta	2.5, 11/4, 3, 3.5, 11/3, 4, 5, 5.5, 6, 7, 8, 9, 10, 11 , 12, 14, A4, B4, Definido
Margem Topo Folha	0, 1/6 , 1/4, 1/3, 1/2, 2/3, 3/4, 1, Definido
Margem Inf. Folha	0 , 1/6, 1/4, 1/3, 1/2, 2/3, 3/4, 1, Definido
Margem Esq. Folha	-7, -6, -5, -4, -3, -2, -1, 0, 1, 2, 3, 4, 5, 6, 7, Definido
Margem Dir. Folha	-7, -6, -5, -4, -3, -2, -1, 0 , 1, 2, 3, 4, 5, 6, 7
Carreg. Auto	Desativo, 0.5sec , 1sec, 1.5sec, 2sec
Tam. Form. Cont.	2.5, 11/4, 3, 3.5, 11/3, 4, 5, 5.5, 6, 7, 8, 9, 10, 11 , 12, 14, A4, B4, Definido
Mar. Topo Form. Cont.	0, 1/6 , 1/4, 1/3, 1/2, 2/3, 3/4, 1, Definido
Mar. Inf. Form. Cont.	0 , 1/6, 1/4, 1/3, 1/2, 2/3, 3/4, 1, Definido
Mar. Esq. Form. Cont.	-7, -6, -5, -4, -3, -2, -1, 0 , 1, 2, 3, 4, 5, 6, 7, Definido
Marg. Topo Form. Cont.	-7, -6, -5, -4, -3, -2, -1, 0 , 1, 2, 3, 4, 5, 6, 7
Salte perfuração	Não , Sim
Corte	Automático , Manual, Curto, Auto@FF
Cigarra	Não, Sim
Modo Marca Preta	Não , Sim
Modo De Pressão	Invalido, Norma, Especial

Confi. Interface	Valores válidos
PnP	Não, Sim
ID USB	Não , Sim

Config. Caráter	Valores válidos
Tabela de caracteres	Italic, Graphic
Grupo de caracteres	Group 1, Group 2
Conj. caracteres Int.	EUA , França, Alemanha, Reino Unido, Dinamarca, Suécia, Itália, Espanha, Japão, Noruega, Dinamarca II, Espanha II, América Lat, Dinamarca, China
Fonte	Draft , DraftCond, Quadrato, QuadratoCond, Courier, CourierCond, OCR B, OCR A
Passo (cpi)	10 , 12, 15, 17, 20, PS
Página de Código	CP437 , CP737
Alta Velocidad	Não, Sim

Tally Dascom 1140

Config. Outros	Valores válidos
Cmd. Tam. de Folha	Não, <i>Sim</i>
Cmd. Vel. Impresso	Não, <i>Sim</i>
Cmd. Passo	Não, <i>Sim</i>
Cmd. Fonte	Não, <i>Sim</i>
Cmd. Imp. Uni-dir	<i>Não</i> , Sim

5.6 Black Mark Parameters

This printer uses tractors to load fanfold forms with pre-printed black marks.

The printer requires 3 parameters to print on paper with black marks:

1. Horizontal offset of black mark from the edge of page (called Black Mark Physical Horizontal Position); later on, this value facilitates the printer to locate its scanner preparing for identifying the black marks.
2. Vertical offset of the first print line from the black mark (called Distance Offset From BlackMark To Print Position); later on, the print makes use of this value to print the first line relative to the black mark.
3. Vertical offset of the tear-off edge from the black mark (called Distance Offset From BlackMark To Tear Position); this value informs the printer the tear-off position of the page.



Not to skip or change the order of setting the above 3 parameters.

The procedures to set the parameters:

1. Hold down the **Tear** key while powering on the printer and then release the key when the print head starts to move. After loading paper, the printer prompts the Printer Settings

Printer Settings

[TEAR]=Back, [LF]=Next, [LOAD/EJECT]=OK, [ONLINE]=Exit,
[ONLINE]+[LOAD/EJECT]=Save and restart the printer.

System Setup

2. Press the **Next** or **Back** keys to scroll forward or backward the sub-menus till the printer shows:

BlackMark Mode

3. Press **OK** to go into the BlackMark menu. The printer prompts:

[Black Mark Adjustment Mode]
[TEAR]= Back, [LF]= Next, [LOAD/EJECT]=OK, [ONLINE]=Exit,
[ONLINE]+[LOAD/EJECT]= Save and restart the printer.

Black Mark Physical Horizontal Position

Press any key to eject the paper, and load paper with black mark in the Fanfold Path.

4. The last prompt above advises you to press any key to unload the dialog form. Then load a fanfold form with black mark.

5. Ensure to place the lever at  position. Then press the **Load/Eject** key to load the black marked form. The top edge of the form will then align with the printer's tear-off blade. Press **Next** or **Back** until you see the black mark marginally exposed out of the tear-off blade. Then press **OK** to allow the printer to scan the horizontal offset of the black mark relative to the left edge of the page. (Meanwhile, the vertical position of the black mark is measured and recorded.)

When the printer fails to scan the horizontal offset (see the below picture), it prompts you to repeat the above procedures. If scanning is successful, it prompts:

Successfully setup black mark parameters.

Distance Offset From Black Mark To Print Position

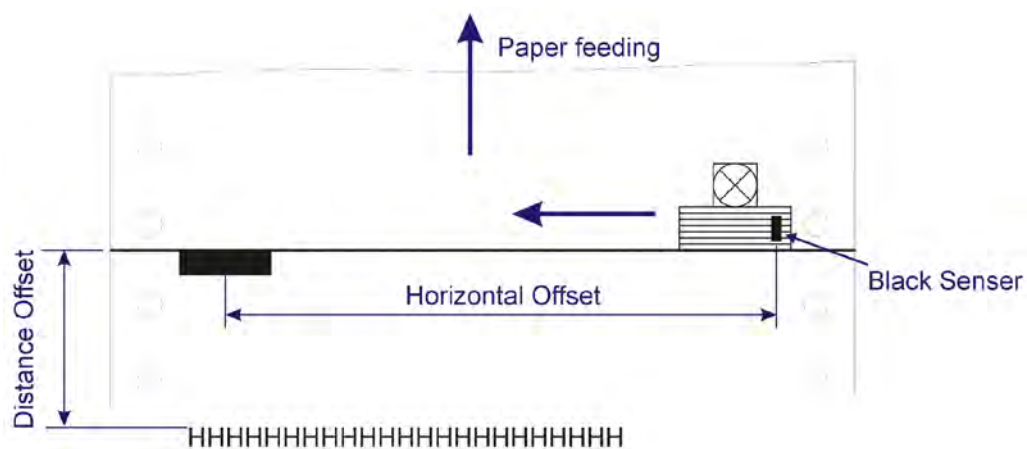

6. The last prompt above invites you to set the next parameter --- vertical offset of the first print line from the black mark. Like other setting dialogs, you have options:
 - 1) to bypass this setting (by pressing **Next** or **Back**), (**WARNING**: Not to skip or change the order in Black Mark Setting.)
 - 2) to accept the Distance Offset (by pressing **OK**),
 - 3) to leave the subsequent settings (by press **Exit**),
 - 4) to terminate the session and save modified parameter(s) (by pressing **Save and Restart**).
7. When you respond with "**OK**" to set the vertical offset, the printer prompts you to reload a black marked fanfold form:

Press any key to eject the paper, and load paper with black mark in the Fanfold Path.

The top edge of the form will then align with the printer's tear-off blade. Press **Next** or **Back** to feed or reverse-feed the paper till the desired first print line position is reached. (With the above measured vertical position, the printer will convert the next paper feeding to the TOF relative to the black mark.) Press **OK** to confirm the vertical offset. Then the print prompts the invitation for setting the tear-off position relative to the black mark:

Successfully setup black mark parameters.

Distance Offset From Black Mark To Tear Position

8. When you respond with **OK** to set the tear-off position, the printer prompts you to reload a black marked fanfold form:

Press any key to eject the paper, and load paper with black mark in the Fanfold Path.

The printer reloads the form. By default the form stops 5.5 inches away from the printer's tear-off blade. Press **Next** or **Back** to feed or reverse-feed the paper till the desired tear-off position is reached. (With the above measured vertical position, the printer will convert the net paper feeding to the tear-off position relative to the black mark.) Press **OK** to confirm the tear-off offset relative to the black mark. Finally, press **Save and Restart** to save new settings and terminate the session.

5.7 Bidirectional Alignment

When wiggling vertical grids appears in tabular reports, you should adjust the Bidirectional Alignment. The procedures to adjust bi-directional alignment across adjacent line grids:

1. Hold down the **Tear** key while powering on the printer and then release the key when the print head starts to move. After loading paper, the printer prompts the Printer Settings.

Printer Settings

[TEAR]=Back, [LF]=Next, [LOAD/EJECT]=OK, [ONLINE]=Exit,
[ONLINE]+[LOAD/EJECT]=Save and restart the printer.

System Setup

2. Press the **Next** or **Back** keys to scroll forward or backward the sub-menus till the printer shows:

Bi-directional Alignment

3. Press **OK** to go into the Bi-directional Test menu. The printer prompts:

[Bi-direction Alignment]
[TEAR]=-1, [LF]=+1, [LOAD/EJECT]=OK, [ONLINE]=Back,
[ONLINE]+[LOAD/EJECT]=Save and restart the printer

20



4. Every press on **+1** or **-1** shifts the second line to the right or left, respectively, relative to the top line by 1 fine step. After pressing **+1** twice and then **OK**, the printer prompts:

22



5. Repeat the adjustment till two grid lines align satisfactory as "|". Press "OK" again. The printer asks if you want to save the correction:

Save the parameter settings ([LOAD/EJECT] or [ONLINE] = OK, [LF] = Next)?
Yes

At this stage, you have the options to save or give up the correction by pressing **OK** or **Next**, respectively. If you respond with **OK**, an asterisk "*" appends to "Yes" to confirm saving change. If you intend to give up the correction by pressing **Next**, the printer prompts a "No" Then a confirmative response of **OK** appends an asterisk "*" to the "No" prompt. The printer then exits the Bi-directional Test and proceeds with the next setup menu.

5.8 Restore Factory Default

The procedures to restore factory default settings:

1. Hold down the **Tear** key while powering on the printer and then release the key when the print head starts to move. After loading paper, the printer prompts the Printer Settings

Printer Settings

[TEAR]=Back, [LF]=Next, [LOAD/EJECT]=OK, [ONLINE]=Exit,
[ONLINE]+[LOAD/EJECT]=Save and restart the printer.

System Setup

2. Press the Next or Back keys to scroll forward or backward the sub-menus till the printer shows:

Restore Factory Defaults

3. Press OK to go into restore factory default dialog. The printer prompts:

[Restore Factory Defaults]

Restore factory settings ([LOAD/EJECT]=OK, [ONLINE]=Exit)?

Yes

4. At this stage you have the option of OK to restore default setting or Exit to discard the restoration.
5. If input OK, the printer prints an asterisk "*" appending the "Yes" and prompts successful restoration:

Restore factory settings successfully

6. The printer beeps once to indicate successful restoration.

5.9 Tally Dascom Printer Config Tool

In the CDROM is a software utility called “Tally Dascom Printer Config Tool”. This application enables a convenient, simple, and fast way to control your printer without touching any keys on the operation panel.

1. Start the tool installation by double clicking the “Tally Dascom Printer Config Tool Setup.msi”.
2. Connect the printer to the system using USB cable
3. Power up the printer.
4. Run the tool from the Windows Start menu by selecting All Programs, then Dascom Printer Setup, and then Tally Dascom Printer Setup.
5. For more information on how to use the tool, go to the Help menu and select User Guide.

6 Customized Form

This printer allows the customization on the form length, **TOF**, bottom margin and left margin for single sheets and fanfold. Restore Factory Defaults can recover these default values.

Selecting the Define value(s) in section 5.2 (Paper Setup menu) allows the printer to take up the customized page formatting value(s).

The parameter setting procedures involve:

1. The printer prompts the dialogs and you follow the prompts.
2. Before every measurement or change, the print instructs you to unload the conversation form from the printer.
3. With the exception of measuring the form length for cut sheets, always set the lever to the tractors position .
4. For form length measurement, insert the customized form from the proper paper path.

The other six settings are actually done on general fanfold forms --- not the actual customized form. Fanfold paper gives direct visual results on the TOF, bottom and left margins even though cut sheets will be used in actual application.

6.1 Customize Cut Sheet Form Length

1. Hold down both the **Online** and **Load/Eject** keys while powering on the printer and then release the keys when the carriage initializes and beeps once. After loading a form the printer prompts:

Customize Form

[TEAR]=Back, [LF]=Next, [LOAD/EJECT]=OK, [ONLINE]=Exit,
[ONLINE]+[LOAD/EJECT]=Save and restart the printer.

Single sheet

2. Press "**OK**" to start customizing all or part of 4 parameters for single sheet. The printer prompts:

[Single sheet]

Form Length

3. You may skip to other customized settings by pressing “**Next**” or “**Back**”. Once you press “**OK**” to continue with form length measurement, the printer prompts:

1. Press any key to clear the Setup Instructions Page from the printer. Insert the Customized Page into the corresponding paper path. Press [LOAD/EJECT] to load and measure the page length.
2. The printer rolls over the entire Customized Page to measure its length. After measurement, press [LOAD/EJECT] to load a blank Setup Instructions Page to report the measured value.
3. Press [LOAD/EJECT] to save the measured value. Repeat the above steps if the printed value is dissatisfactory.

Illustrations for above step 1 and step 2.

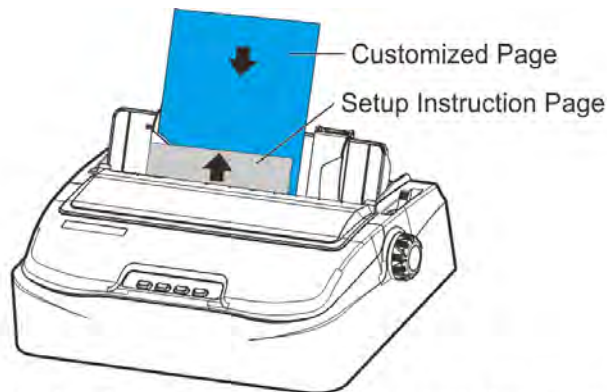

Remove Setup Instructions Page and insert Customized Page.

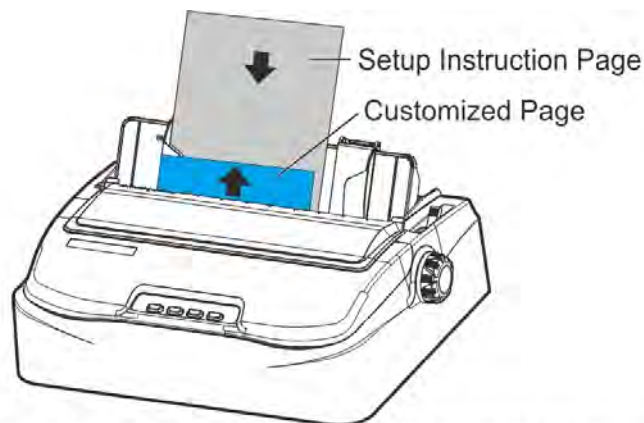

Insert a blank Setup Instructions Page to print out measured value

4. Follow the given prompt to unload the conversation form. Load the customized form to allow the printer to scan the page length. After the measurement, load another conversation form to let the printer print out the measured length.

The measured form length is: 11.0Inch, approximately equal to 279mm, accuracy of plus or minus 0.1 inches.

The measured value has been saved. Remeasure ([LOAD/EJECT]=OK, [ONLINE] =Exit)?

Yes

5. At this stage:

If **Load/Eject** is pressed, an asterisk "*" is appended to "Yes" and you should repeat the procedures for form length measurement as mentioned. Or,
If you input "**Exit**", the printer saves the measurement value and proceeds with the next customized setting.

6.2 Customize Cut Sheet TOF

1. After you follow through all the steps in 6.1 or you input "**Next**" in step 3 in 6.1, the printer prompts:

Top Margin

2. You may skip to other customized settings by pressing "**Next**" or "**Back**". Once you press "**OK**" to continue with customization of cut sheet TOF, the printer prompts:

Press any key to eject current page, load paper in the Fanfold paper path, and then proceed as follows:

[TEAR] = -(1/72) inch, [LF] = +(1/72) inch, [LOAD/EJECT] = OK, [ONLINE] = Exit, [ONLINE] + [LOAD/EJECT] = Save and restart the printer.

3. Follow the given prompt to unload the conversation form. Ensure the lever is at  position. Then press the **Load/Eject** key to load fanfold paper from tractors. The top edge of the form initially aligns with the printer's tear-off blade. You may input "+/- 1/72" to adjust the TOF position. When you get the desirable TOF, press **OK** or **Exit**. The printer prompts the customized TOF value:

The defined position is: 4.2 mm.

Save the parameter settings ([LOAD/EJECT] or [ONLINE]=OK, [LF]=Next)?

Yes

4. At this stage:

If **Load/Eject** is pressed, an asterisk "*" is appended to "Yes" and you should repeat the procedures for form length measurement as mentioned. Or,
If you input "**Exit**", the printer saves the measurement value and proceeds with the next customized setting.

6.3 Customize Cut Sheet Bottom Margin

1. After you follow through all the steps in 6.2 or you input "**Next**" twice in step 3 in 6.1, the printer prompts:

Bottom Margin

2. The remaining operations are nearly the same as described in section 6.2. The only difference is to input "+/- 1/72" till you get the desirable bottom margin.

6.4 Customize Cut Sheet Left Margin

1. After you follow through all the steps in 6.3 or you input “**Next**” three times in step 3 in 6.1, the printer prompts:

Left Margin

2. The remaining operations are nearly the same as described in section 6.2. The only difference is to input “**+/- 1/72**” till you get the desirable left margin.

6.5 Customize Fanfold Page Formatting Parameters

The customizations of the form length, TOF, bottom and left margins for fanfold are exactly the same as describe. All you need is to bypass the Single Sheet menu under Customize Form. Follow step 1 in section 6.1:

Customize Form

[[TEAR]=Back, [LF]=Next, [LOAD/EJECT]=OK, [ONLINE]=Exit,

[ONLINE]+[LOAD/EJECT]=Save and restart the printer.

Single sheet

Then hit “Next” instead to get into the fanfold parameter menus:

[Tractor Paper]
Form Length

Refer section 6.1 to 6.4 for details on customizing the form length, TOF, bottom margin, and left margin for fanfold.

7 Maintenance

Your printer requires very little care. Occasional cleaning and replacement of the ribbon cartridge are all that is required. Cleaning is recommended approximately every 6 months or 300 hours of operation, whichever is sooner. Lubrication of the printer is not usually necessary. If the print head carriage does not move smoothly back and forth, clean the printer in the manner described in this chapter. If the problem continues, contact your dealer to determine whether lubrication may be necessary.

 **Switch printer off and unplug the power cord from the main before doing any maintenance work.**

7.1 Cleaning

The housing and the top cover of the printer help protect it against dust, dirt, and other contaminants. However, paper produces small particles that accumulate inside the printer. This section explains how to clean and vacuum the printer and how to clean the paper bail rollers. It is easier to clean the printer when the cover is open.

7.2 Cleaning and Vacuuming the Printer

If the print head carriage does not move smoothly back and forth or paper particles have accumulated in the printer, clean the printer.

To clean and vacuum the printer:

1. Remove any paper from the printer. Make sure that the power is off, and then disconnect the printer power cord.
2. Using a soft vacuum brush, vacuum the exterior of the printer. Also vacuum the cut sheet edge.
3. Use a soft, damp cloth to wipe the exterior of the printer, including the cover. A mild detergent may be used. Do not use solvents, kerosene, or abrasive cleaning materials that may damage the printer.
4. Open the cover of the printer and remove the ribbon cartridge. Using a soft vacuum brush, gently vacuum the platen, the print head carriage and shaft, and surrounding areas. You can easily slide the print head to the left or right when the power is off. Be careful not to press too hard on the flat head cable that extends from the print head carriage.
5. Re-install the ribbon cartridge.
6. Remove the single sheet feeder and clean the form tractors and the surrounding areas.
7. Re-install the single sheet feeder.

7.3 Cleaning the Paper Rollers

Clean the platen and paper bail rollers occasionally or when stains or smudges appear on the paper. Use a mild detergent as appropriate. Do not use alcohol to clean the platen or the rollers. Alcohol may cause the rubber to harden.

To clean the rollers and the platen:

1. Apply a small amount of water to a soft cloth. Avoid spilling liquid inside the printer.
2. Place the cloth against the platen and manually rotate the paper feed knob.
3. Repeat this procedure for each roller.
4. To dry the platen, place a dry cloth against the platen and the rollers and manually rotate the paper feed knob.

8 Troubleshooting

Your printer is extremely reliable, but occasionally problems may occur. This chapter provides information on some of the common problems you may encounter and how you may solve them. If you encounter problems that you cannot resolve, contact your dealer or service partner for assistance.

8.1 Print Quality Problems and Solutions

Problem	Solution
Printing is too light or too dark.	<ul style="list-style-type: none"> ● Make sure that the ribbon cartridge is properly installed and that the ribbon feeds smoothly. ● Replace the ribbon if necessary. ● Make sure that the print gap lever is set for the thickness of your paper.
Smears and stains appear on the page.	<ul style="list-style-type: none"> ● Make sure that the print gap lever is set for the thickness of your paper. ● Check for ribbon wear. Replace the ribbon if necessary. ● Check whether the tip of the print head is dirty. Clean the head with a soft cloth if necessary. ● The print head may need to be replaced.
Printing is erratic or the wrong characters are printed. Many “?” or unexpected characters are printed.	<ul style="list-style-type: none"> ● Make sure that the interface cable is securely connected to both the printer and computer. ● Make sure that the printer driver selected in your software is the same as the emulation selected on the printer. ● Check the length of the interface cable. (Maximum Parallel & USB: 2 meters, Serial: 15 meters) ● Try another interface cable.
The page is blank.	<ul style="list-style-type: none"> ● Make sure that the ribbon cartridge is properly installed. ● Make sure the gap lever is set correctly.
Printing is vertically misaligned (jagged).	Use the printer's vertical alignment function to check the vertical print alignment. If necessary, adjust the print alignment.
The top margin is wrong.	<ul style="list-style-type: none"> ● Check the application top margin setting. ● Adjust the Top Margin setting in Page Setup menu if necessary.
Lines are double spaced instead of single spaced.	<ul style="list-style-type: none"> ● Change the Auto LF setting in the System Setup menu to No.
The printer overprints on the same line.	<ul style="list-style-type: none"> ● Change the Auto CR setting in the System Setup menu to No.

Problem	Solution
The next print line starts where the previous line ended instead of at the left margin.	<ul style="list-style-type: none"> ● Change the Auto CR setting in the System Setup menu to Yes.

8.2 Paper Handling Problems and Solutions

Problem	Solution
Paper cannot be loaded or fed.	<ul style="list-style-type: none"> ● Make sure that the paper select lever located on the top right of the printer is set correctly. Move the lever to the front for single sheets or to the rear for continuous forms. ● Make sure that the paper covers the paper-out sensor.
Paper jams while loading.	<ul style="list-style-type: none"> ● Turn off the printer and remove the jammed paper. Remove any obstructions from the paper path. ● Make sure that the Print Gap lever is set for the thickness of your paper. ● Make sure that the paper is not folded, creased, or torn. ● Make sure that the left and right tractors are set so that the continuous forms are stretched taut.
Paper jams while printing.	<ul style="list-style-type: none"> ● Turn off the printer and remove the jammed paper. Remove any obstructions from the paper path. ● Make sure that the Print Gap lever is set for the thickness of your paper. ● For continuous forms, make sure that the incoming and outgoing paper stacks are correctly placed. Paper should feed straight.
Paper slips off the forms tractors or the perforated holes of the paper tear during printing.	Make sure that the forms tractors are positioned correctly for the width of your paper and that the perforated holes of the paper fit directly over the tractor pins.

8.3 Operating Problems and Solutions

Problem	Solution
The power does not turn on.	<ul style="list-style-type: none">● Check whether the mains voltage is correct.● Make sure that the power cord is securely connected to both the printer and the mains power outlet.● Make sure that the power outlet is functional. If not so, use other outlet.● Turn the power off. Wait a minute and then turn the printer on again. If the printer still has no power, contact your dealer.
The printer is on but it will not print.	<ul style="list-style-type: none">● Make sure that the Online indicator is lit.● If you use the interface cable, make sure it is securely connected to both the printer and the computer.● Make sure paper is loaded.● Run the printer Status Page. If printing executes normally, the problem is caused by: the interface, the computer, incorrect printer settings, or incorrect software settings.● Make sure that the printer driver selected in your software is the same as the emulation selected on the printer.
Paper select lever error	If paper is loaded and the paper select lever is moved to the incorrect position, the printer turns offline, and the buzzer sounds continuously. Switch the paper select lever back to its correct position.

8.4 Printer Failures

A user cannot generally resolve a problem involving defective printer hardware. Power off and on again the printer to recover any fatal error. If the problem cannot be resolved, contact your dealer or service partner.

8.5 Error Indications on LEDs

Error Description	Power LED	Font1 LED	Font2 LED	Online LED	Buzzer Sound
Print head too hot	Flashing	No change	No change	Flashing	None
Paper path switching problem	Flashing	No change	No change	Flashing	Continuous
Paper jam	Flashing	No change	No change	On	Once
Paper End	Flashing	No change	No change	Off	Once
Carriage initial position	Off	Off	Flashing	Flashing	Continuous
Code Stripe problem	Off	Off	Flashing	Flashing	Continuous
Paper sensor failure	Flashing	No change	No change	Off	Once
Paper width problem	Flashing	No change	No change	Off	None
Print head thermal sensor failure	Off	Off	Off	Flashing	None

8.6 Diagnostic Functions

The printer diagnostic functions are Self-Test page, hex-dump mode and print alignment adjustment.

- **Self-Test page:** Tells you whether the printer hardware is functioning correctly. If the printer hardware is functional, any problems you are having are probably caused by incorrect printer settings, incorrect software settings, the interface, or the computer.
- **HEX-DUMP MODE:** Allows you to determine whether the computer is sending the correct commands to the printer, and whether the printer is executing the commands correctly. This function is useful to programmers or others who understand how to interpret hex dumps.

PRINTING ALIGNMENT ADJUSTMENT: Allows you to check and, if necessary, correct the printer's vertical line print alignment in bi-directional mode.

For details on using these functions, please refer to chapters 4 and 5.

8.7 Firmware Update

Sometimes it is necessary to update the firmware to solve a problem. The latest firmware file may be obtained from your dealer or downloaded from our website www.dascom.com. Before updating firmware, it is strongly recommended to print the Main Menu page to keep a record of the old settings.

Note: Firmware update should only be performed by an authorized service person. We disclaim any responsibility for any damage caused if it is performed by any other person.

To load new firmware, proceed as follows:

1. Switch off the printer. Connect your PC to the USB port on the printer.
2. Link Configuration Tool and then click “Firmware Update” as shown in below picture:

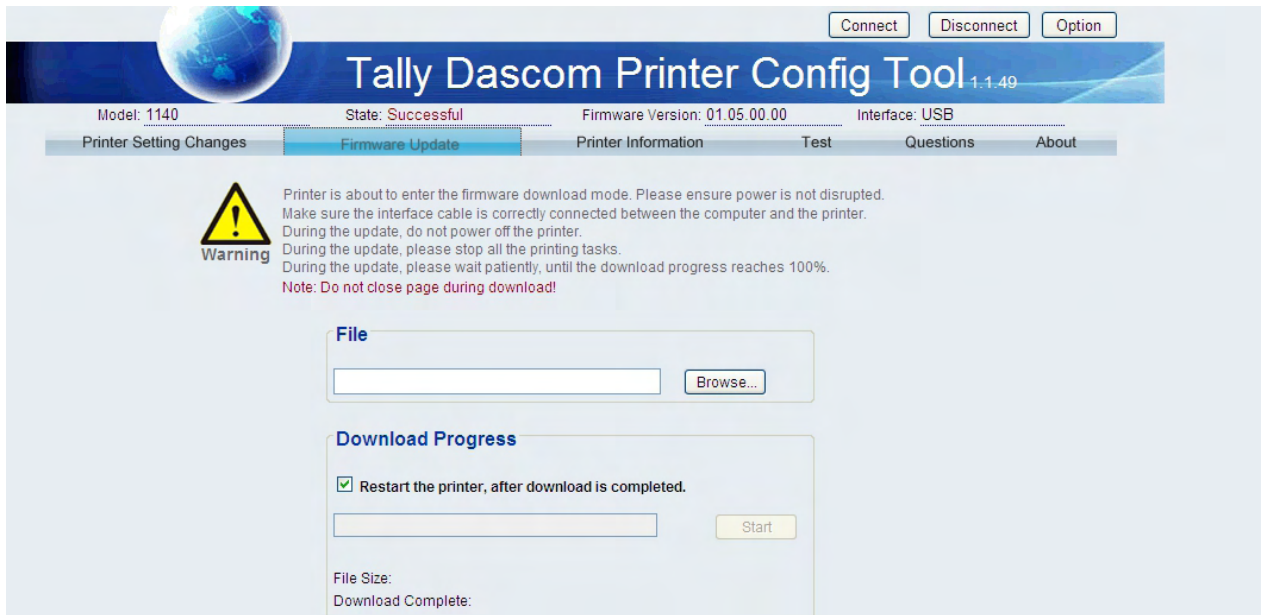

3. Click “Browse” to choose program file and character set, then Click “Start” ,following message is prompted. Click “OK”.

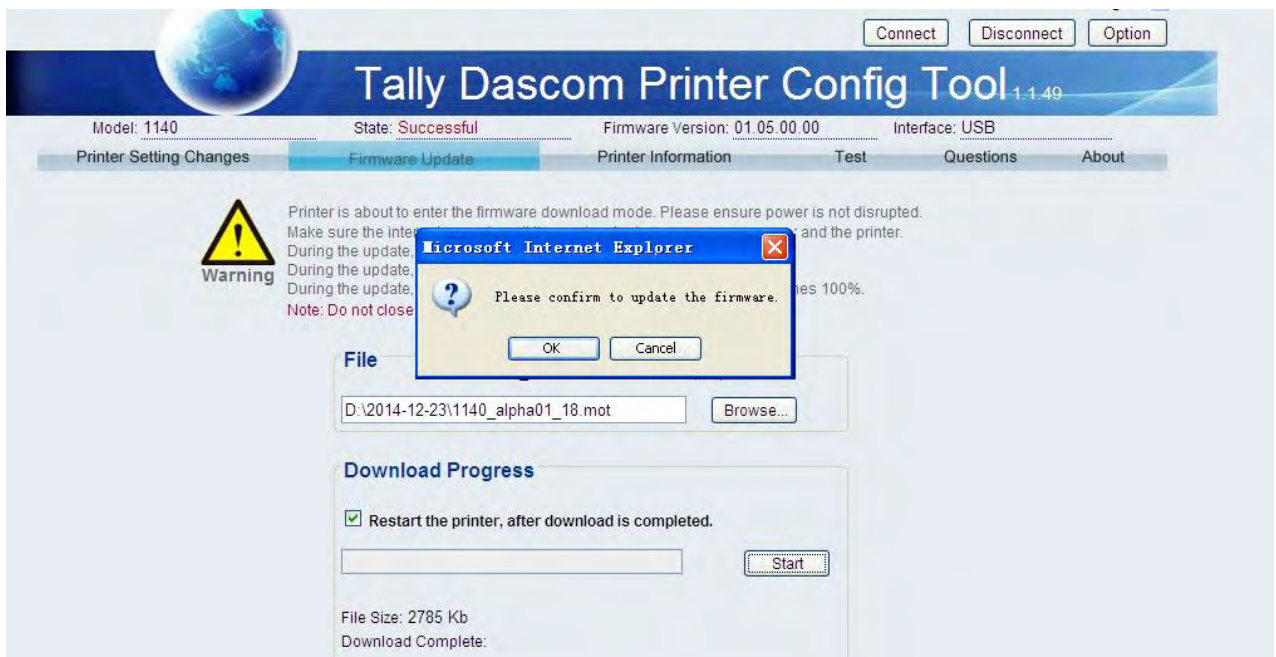

Tally Dascom 1140

4. Enter download process and it is shown as below picture. In this process, L1 and L2 are on; And L3 and L4 are blinking.

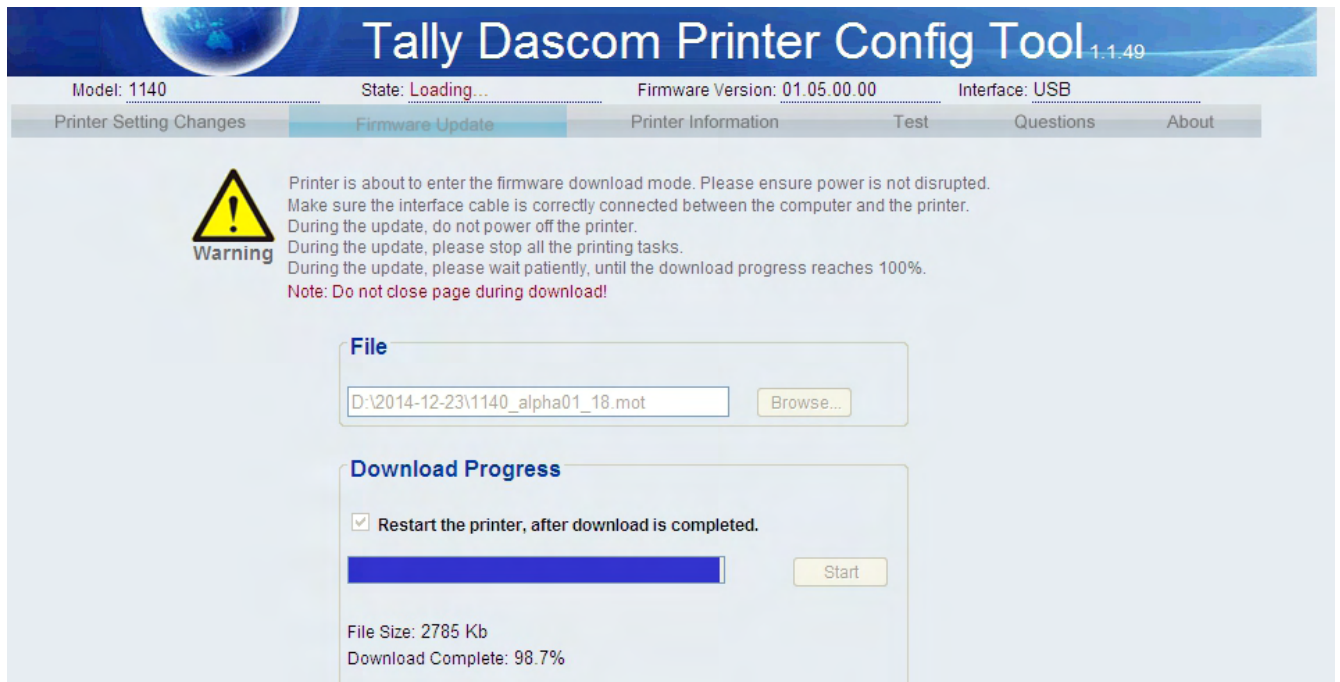

5. When download is completed, the carriage returns to home position. Printer initializes normally.

9 General Specifications

Print System	Mono-chrome serial impact dot matrix			
Print Technology	Uni-/bi-directional logic seeking for text and graphics			
Print Speed	Pitch	NLQ	Draft	HS Draft(CPS/DPI)
	10 CPI	75/240H	300/120H	400/90H
	12 CPI	90/240H	360/120H	360/120H
	15 CPI	75/360H	300/180H	300/180H
	17CPI	127/240H	340/180H	340/180H
Font Matrix	Pitch	NLQ	Draft	HS Draft(Matrix/DPI)
	10 CPI	24H*18V/240	12H*9V/120	9H*9V/90
	12 CPI	20H*18V/240	10H*9V/120	10H*9V/120
	15 CPI	24H*18V/360	12H*9V/180H	12H*9V/180H
	17CPI	14H*18V/240	10H*9V/180H	10H*9V/180H
Print Head	Number of pins:	9 pins		
	Firing frequency:	Normal mode: 1800 Hz		
	Pin diameter:	0.3 mm		
	Life:	400 million strokes/pin @ Draft mode		
Graphics	8-bit mode: 8V x 60H, 72H,80H, 90H, 120H, 144H,240H (DPI)			
Paper Feed Speed	Continuous feed: 4.0 IPS (inches per second)			
Resolution	240x 144 DPI maximum			
Printable Columns	Characters per line (CPL)			
	10 CPI:	80 CPL		
	12 CPI:	96 CPL		
	15 CPI:	120 CPL		
	17.1 CPI:	136 CPL		
20 CPI:	160 CPL			
Built-In Fonts	Bitmap Fonts:			
	1. Draft	10, 12, 15, 17.1CPI,		
	2. Quadrato	10, 12, 15, 17.1, 20CPI,Proportional		
	3. Courier	10, 12, 15, 17.1, 20CPI, Proportional		
	4. HS-draft	10CPI		
	5. OCR-A			
6. OCR-B				
Barcodes	1. EAN-13			
	2. EAN-8			
	3. Interleaved 2 of 5			
	4. UPC-A			
	5. UPC-E			
	6. Code 39			
	7. Code 128			
	8. POSTNET			

Tally Dascom 1140

Code Pages	CP 437, CP 737, CP 850, CP 851, CP 852, CP 857, CP 858, CP 860, CP 861, CP 863, CP 1252, CP 1253, CP 1254, 8859-1, 8859-1 (SAP), 8859-2, 8859-5, 8859-7, 8859-9, 8859-15, Kamenicky , Mazovia, 866 Bulgaria, CP 1250, CP 1251, BRASCII, Abicomp, CP 865, CP 866, CRO-ASCII		
International Character Sets	USA, France, Germany, UK, Denmark I, Sweden, Italy, Spain I, Japan, Norway, Denmark II, Spain II, Latin America, Danmark/ Norway, China		
Line Spacing	1/6", 1/8", n/72", n/216"		
Paper Specifications	Cut Sheet		Fanfold Paper
			Single ply Multi-part
	Width:95mm~267mm (3.75"~10.5") Length:114.3mm~363.2mm (4.5"~14.3")		Width: 95mm~267mm (3.75"~10.5") Length: 114.3mm~558.8mm (4.5"~22.0")
	Weight: 52~100g/m ² Thickness: 0.065~0.14mm (0.0026"~0.0055")	Weight: 52~100 g/m ² Thickness: 0.065~0.14mm (0.0026"~0.0055")	Weight: 40~56g/m ² Thickness: 0.52 mm max (0.0204" max)
Paper Handling	Feeding method: Friction/Push tractor/Roll paper Paper path: Cut sheets: Rear in and top out Fanfold: Rear in and top out		
Copy Capability	Original + 4 copies		
Emulation	ESC/P2, IBM 2380+		
Ribbon Type	Cartridge; Monochrome		
Ribbon Life	9 million characters (rolling Draft 10 CPI)		
Input Data Buffer	Up to 256KB		
Windows Drivers	Windows Server 2000/2003/2008 Windows Vista Windows XP Windows 98 Windows 7 Windows 8.1 Windows Server 2012		
Interface	Standard: USB Options: Parallel, Serial, Ethernet, WiFi, Bluetooth		
Operation Panel	Switches: 4 pcs LED indicators: 4 pcs		

Tally Dascom 1140

Noise Level	Approx. 57 dB(A)
Ambient Conditions	Temperature Operating : +5 to +35 °C Stand-by : -20 to + 55°C Humidity Operating : 10 to 80% RH (No condensation) Stand-by : 5 to 85% RH
Dimensions	369 mm (width) × 283.3 mm (depth) × 130 mm (height)
Weight	approx. 5.5 kg
Power Supply	Unit type : Switching mode power supply Power cord : Detachable Voltage rating : AC 120V~230V, 50Hz to 60Hz
Power consumption	Average power consumption: 29 W (Test pattern is specified in standard ISO/IEC 10561.) Power consumption of sleep mode :1.17W
MTTR	< 20 minutes
MTBF	12,000 hours
MVBF	24 mil lines
Certification	CE, UL, FCC, ES2.0, ISTA, RoHS, WEEE, REACH, ChemVerbotsV, Microsoft Certified for Windows 7, Windows 8.1, Windows Server 2012R2

10 Interfaces

10.1 Parallel Interface

Parallel Interface Pin Assignment

Pin	Signal Name	Signal Transmission
1	STROBE	Printer ← Computer
2~9	DATA	Printer ← Computer
10	ACK	Printer → Computer
11	BUSY	Printer → Computer
12	PE	Printer → Computer
13	SELECT	Printer → Computer
14	AFXT	Printer ← Computer
15	Unused	Unused
16	GND	Printer ↔ Computer
17	F-GND	Printer ↔ Computer
18	+5V	Printer → Computer
19~30	GND	Printer ↔ Computer
31	INIT	Printer ← Computer
32	FAULT	Printer → Computer
33	GND	Printer ↔ Computer
34	Unused	Unused
35	FUSE	Printer → Computer
36	SLCTIN	Printer ← Computer

Parallel Interface Connector Diagram

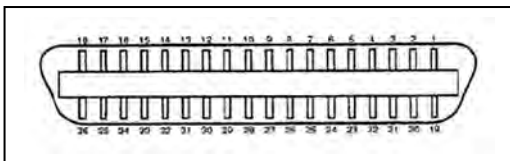

Note: Any external devices connected to the parallel port should not draw current exceeding 200 mA from pin 18; otherwise it may affect the printer operation.

Tally Dascom 1140

10.2 USB Interface

The USB interface conforms to the Universal Serial Bus 2.0 Specifications. It supports the Full Speed mode at 12 Mbps. It uses the “B” type USB connector.

10.3 Serial interface

Serial interface pin assignment

Pin	Signal name	Description
1		
2	RXD	Receive data
3	TXD	Send data
4	DTR	Data terminal ready
5	SGND	Signal ground
6	DSR	Data set ready
7	RTS	Request to send
8	CTS	Clear to send
9		

Serial interface connector diagram

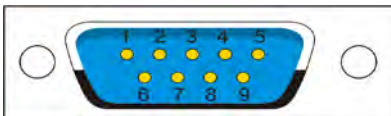

Serial interface wiring diagram

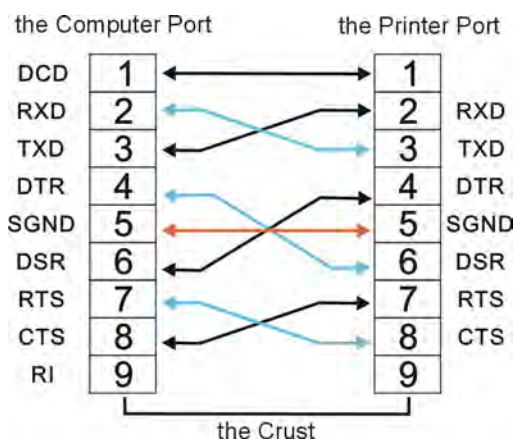

Tally Dascom 1140

Note:

- 1. The serial cable length should not exceed 15 meters.
- 2. Make sure the "Interface Setup" selects serial interface and the settings are the same as PC communication port settings. Shown as below:

Interface:	Share	Share
Baud Rate:	38400	38400
Data Bit:	8	8
Parity Check:	None	None
Stop Bit:	1	1
Data Stream:	Hardware	Hardware

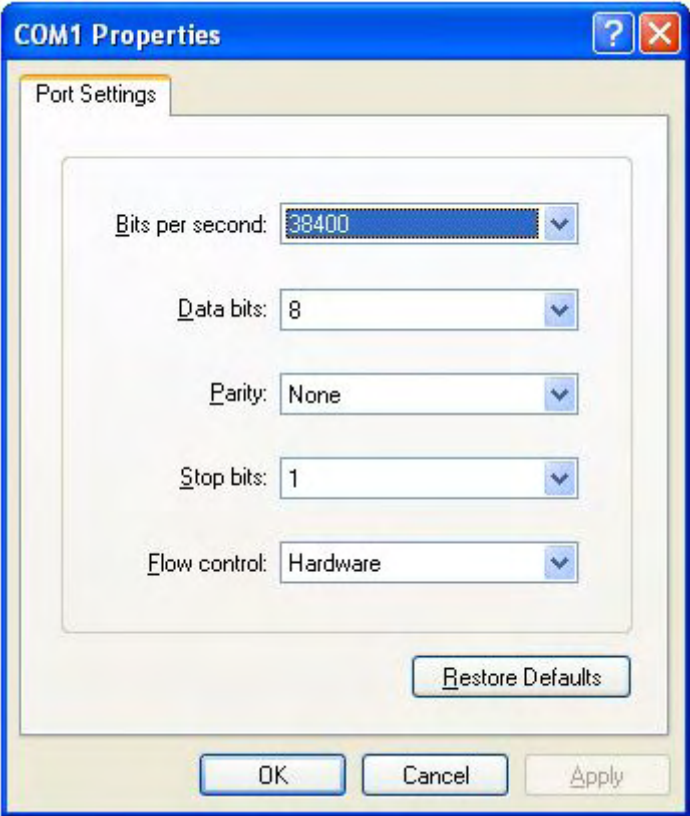

10.4 Bluetooth interface

Install Bluetooth adapter (V2.0 or above version) prepared by yourself in the PC via USB interface.

The effective range of the Bluetooth is 10 meters, so make sure the distance between the printer and the PC is within this range. The baud rate is 38400.

Follow below steps to install Bluetooth adapter driver.

1. Double click the Bluetooth icon  at lower right corner on the PC screen. You will see the following window then Click “Add a device”.

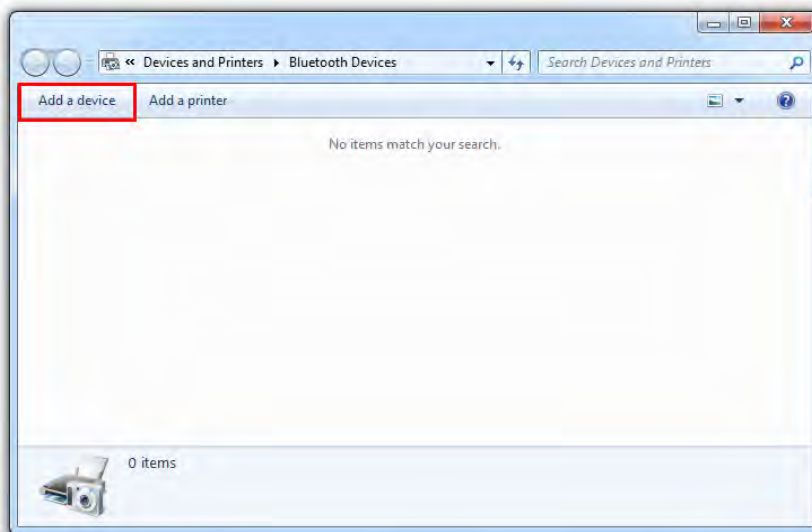

2. Select “Device is ready for searching”, and then click the model name for searching the Bluetooth printer. And enter Next to continue.

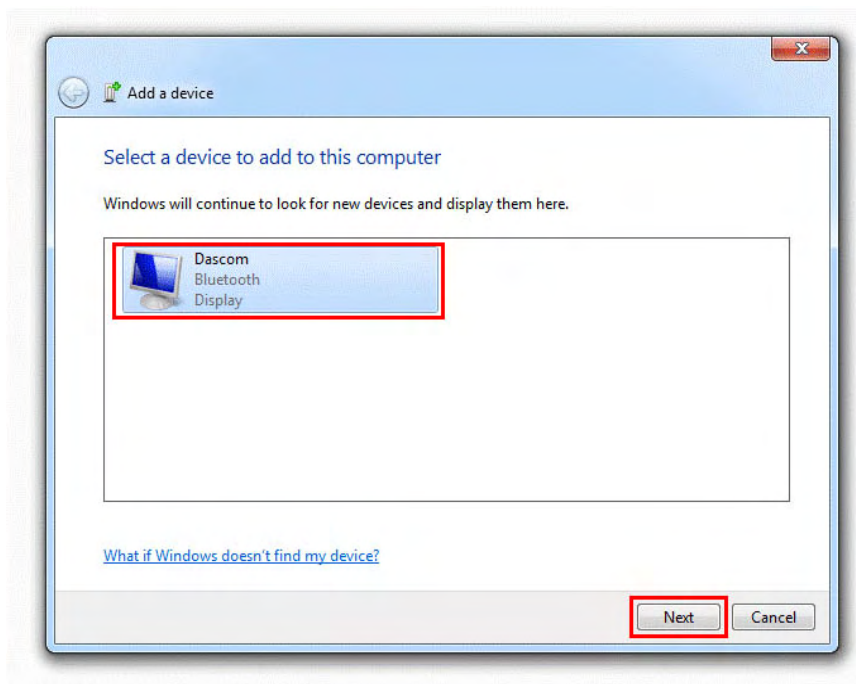

3. Then the bluetooth adapter has been installed in the computer.

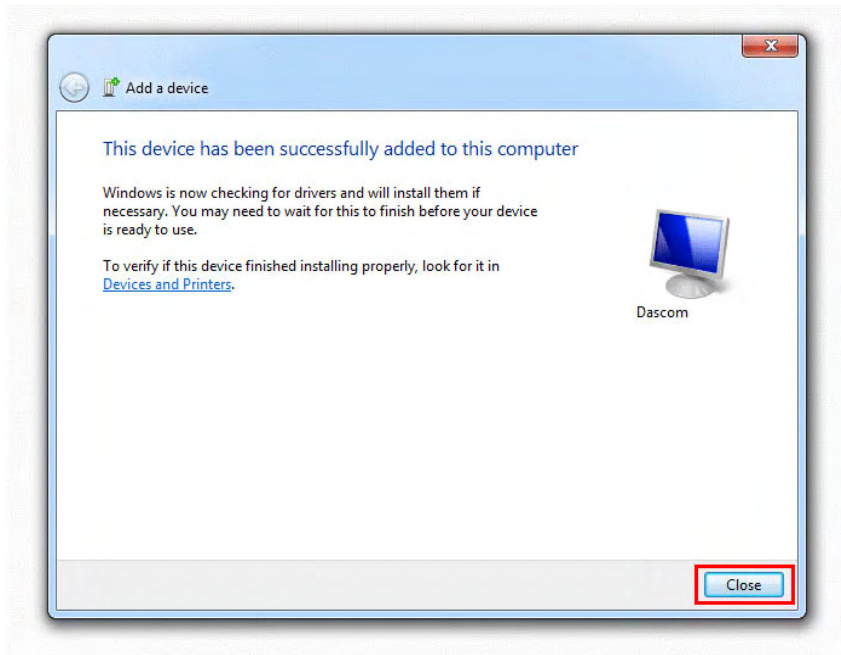

4. Check the port type under the table of Services. In this case, it is COM4.

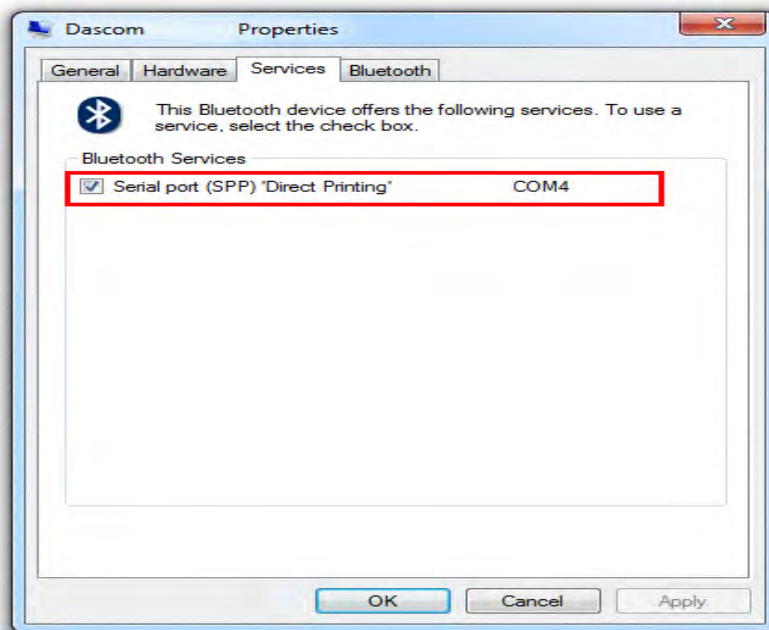

Note:

1. If connection failed, please check the distance between the printer and the computer is within 10m and power is on. You may restart the printer or the computer to try again.
2. Make sure the PC Bluetooth adapter is working, it is installed properly and connected to the computer.
3. If the computer reports the pin is wrong, please make sure you enter four-number password (0000).

Tally Dascom 1140

Follow below process to change Driver Port of PC:

1. Right click the printer, select Properties → Ports, and select the output port that you have put down (in the case COM4) then click “Apply”.

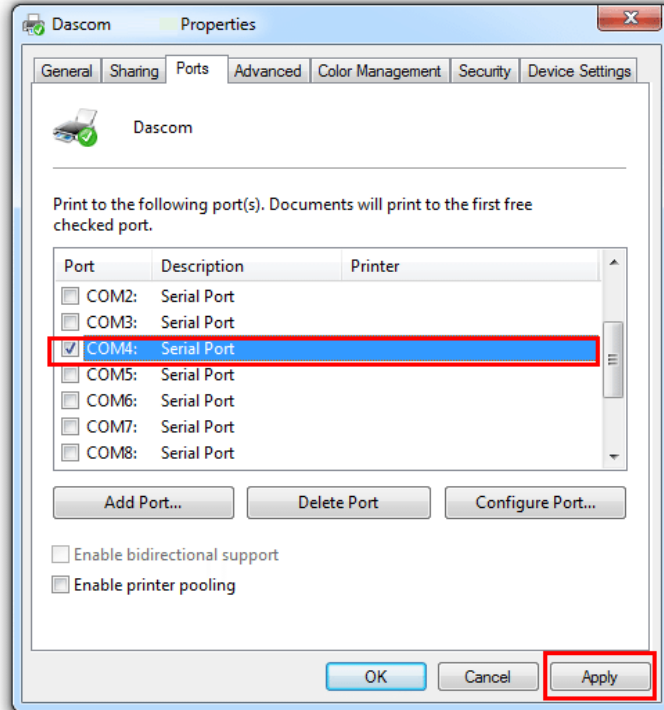

2. COM4 for the printer is checked.

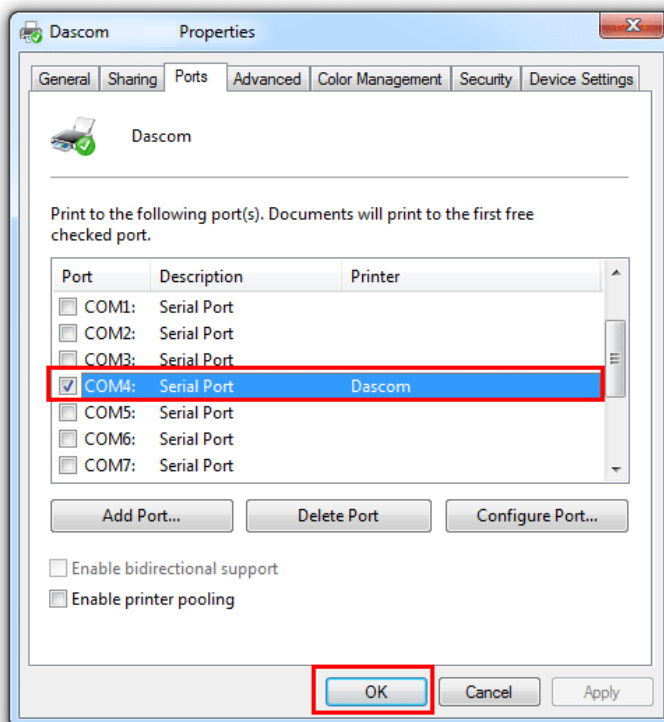

Tally Dascom 1140

3. Select “General” and click “Print test page” for checking Bluetooth performance.

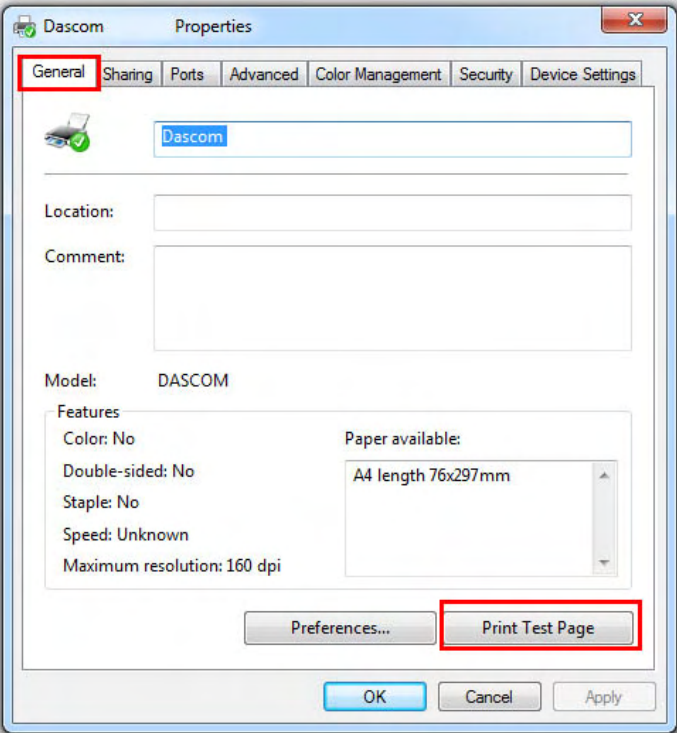

Note:

If failed to print Test Page, please check if you select the right Port Type in the computer.

11 Character sets & Code Pages

11.1 Character Sets

Standard character set 1

	0	1	2	3	4	5	6	7	8	9	A	B	C	D	E	F
0	NUL		SP	0	@	P	¢	p	NUL		0	@	P	¢	p	
1		DC1	!	1	A	Q	a	q		DC1	!	1	A	Q	a	q
2		DC2	"	2	B	R	b	r		DC2	"	2	B	R	b	r
3		DC3	#	3	C	S	c	s		DC3	#	3	C	S	c	s
4		DC4	\$	4	D	T	d	t		DC4	\$	4	D	T	d	t
5			%	5	E	U	e	u			%	5	E	U	e	u
6			&	6	F	V	f	v			&	6	F	V	f	v
7	BEL		'	7	G	W	g	w	BEL		'	7	G	W	g	w
8	BS	CAN	(8	H	X	h	x	BS	CAN	(8	H	X	h	x
9	HT)	9	I	Y	i	y	HT)	9	I	Y	i	y
A	LF		*	:	J	Z	j	z	LF		*	:	J	Z	j	z
B	VT	ESC	+	;	K	[k	{	VT	ESC	+	;	K	[k	{
C	FF	FS	,	<	L	\	l		FF	FS	,	<	L	\	l	
D	CR		-	=	M]	m	}	CR		-	=	M]	m	}
E	SO		.	>	N	^	n	~	SO		.	>	N	^	n	~
F	SI		/	?	O	_	o		SI		/	?	O	_	o	DEL

Standard character set 2

	0	1	2	3	4	5	6	7	8	9	A	B	C	D	E	F
0	NUL		SP	0	@	P	¢	p	ª	§		0	@	P	¢	p
1		DC1	!	1	A	Q	a	q	ë	ß	!	1	A	Q	a	q
2		DC2	"	2	B	R	b	r	ù	£	"	2	B	R	b	r
3		DC3	#	3	C	S	c	s	ò	¤	#	3	C	S	c	s
4		DC4	\$	4	D	T	d	t	ï	ø	\$	4	D	T	d	t
5			%	5	E	U	e	u	*	ø	%	5	E	U	e	u
6			&	6	F	V	f	v	£	"	&	6	F	V	f	v
7	BEL		'	7	G	W	g	w	í	Å	'	7	G	W	g	w
8	BS	CAN	(8	H	X	h	x	¿	Ø	(8	H	X	h	x
9	HT)	9	I	Y	i	y	ŕ	Ù)	9	I	Y	i	y
A	LF		*	:	J	Z	j	z	ñ	Å	*	:	J	Z	j	z
B	VT	ESC	+	;	K	[k	{	π	ø	+	;	K	[k	{
C	FF	FS	,	<	L	\	l		ŕ	ù	,	<	L	\	l	
D	CR		-	=	M]	m	}	À	ß	-	=	M]	m	}
E	SO		.	>	N	^	n	~	ä	é	.	>	N	^	n	~
F	SI		/	?	O	_	o		©	£	/	?	O	_	o	DEL

Tally Dascom 1140

IBM character set 1

	0	1	2	3	4	5	6	7	8	9	A	B	C	D	E	F
0	NUL		SP	0	@	P	'	p	NUL		á	⋮	⊥	⊥	α	≡
1		DC1	!	1	A	Q	a	q		DC1	í	⋈	⊥	⊥	β	±
2		DC2	"	2	B	R	b	r		DC2	ó	⋈	⊥	⊥	Γ	≥
3		DC3	#	3	C	S	c	s		DC3	ú		⊥	⊥	π	≤
4		DC4	\$	4	D	T	d	t		DC4	ñ	⊥	⊥	⊥	Σ	∫
5			%	5	E	U	e	u			Ñ	⊥	⊥	⊥	σ	∫
6			&	6	F	V	f	v			a	⊥	⊥	⊥	μ	+
7	BEL		'	7	G	W	g	w	BEL		o	⊥	⊥	⊥	τ	≈
8	BS	CAN	(8	H	X	h	x	BS	CAN	¿	⊥	⊥	⊥	Φ	°
9	HT)	9	I	Y	i	y	HT		⊥	⊥	⊥	⊥	Θ	•
A	LF		*	:	J	Z	j	z	LF		⊥	⊥	⊥	⊥	Ω	.
B	VT	ESC	+	;	K	[k	{	VT	ESC	½	⊥	⊥	■	δ	√
C	FF	FS	,	<	L	\	l		FF	FS	¼	⊥	⊥	⊥	∞	n
D	CR		-	=	M]	m	}	CR		i	⊥	⊥	⊥	∅	₂
E	SO		.	>	N	^	n	~	SO		«	⊥	⊥	⊥	ε	■
F	SI		/	?	O	_	o		SI		»	⊥	⊥	⊥	∩	SP

IBM character set 2

	0	1	2	3	4	5	6	7	8	9	A	B	C	D	E	F
0	NUL		SP	0	@	P	'	p	Ç	É	á	⋮	⊥	⊥	α	≡
1		DC1	!	1	A	Q	a	q	ü	æ	í	⋈	⊥	⊥	β	±
2		DC2	"	2	B	R	b	r	é	Æ	ó	⋈	⊥	⊥	Γ	≥
3	♥	DC3	#	3	C	S	c	s	â	ô	ú		⊥	⊥	π	≤
4	♦	DC4	\$	4	D	T	d	t	ã	ö	ñ	⊥	⊥	⊥	Σ	∫
5	♣	§	%	5	E	U	e	u	à	ò	Ñ	⊥	⊥	⊥	σ	∫
6	♠		&	6	F	V	f	v	â	û	a	⊥	⊥	⊥	μ	+
7	BEL		'	7	G	W	g	w	ç	ù	o	⊥	⊥	⊥	τ	≈
8	BS	CAN	(8	H	X	h	x	ê	ÿ	¿	⊥	⊥	⊥	Φ	°
9	HT)	9	I	Y	i	y	ë	Ö	⊥	⊥	⊥	⊥	Θ	•
A	LF		*	:	J	Z	j	z	è	Ü	⊥	⊥	⊥	⊥	Ω	.
B	VT	ESC	+	;	K	[k	{	ï	ç	½	⊥	⊥	■	δ	√
C	FF	FS	,	<	L	\	l		î	£	¼	⊥	⊥	⊥	∞	n
D	CR		-	=	M]	m	}	ì	¥	i	⊥	⊥	⊥	∅	₂
E	SO		.	>	N	^	n	~	Ä	Pt	«	⊥	⊥	⊥	ε	■
F	SI		/	?	O	_	o		Å	f	»	⊥	⊥	⊥	∩	SP

Tally Dascom 1140

OCR-A character set 1

	0	1	2	3	4	5	6	7	8	9	A	B	C	D	E	F
0	NUL		SP	0	H	P	'	p	NUL							
1		DC1	4	J	A	Q	a	q		DC1						
2		DC2	w	2	B	R	b	r		DC2						
3		DC3	J	3	C	S	c	s		DC3						
4		DC4	#	4	D	T	d	t		DC4						
5			%	5	E	U	e	u								
6			&	6	F	V	f	v								
7	BEL		'	7	G	W	g	w	BEL							
8	BS	CAN	{	8	H	X	h	x	BS	CAN						
9	HT		}	9	I	Y	i	y	HT							
A	LF		*	:	J	Z	j	z	LF							
B	VT	ESC	+	;	K	E	k	(VT	ESC						
C	FF	FS	~	■	L	\	l		FF	FS						
D	CR		.	=	M]	m)	CR							
E	SO		.	■	N	^	n	~	SO							
F	SI		/	?	0	_	o	■	SI							

OCR-A character set 2

	0	1	2	3	4	5	6	7	8	9	A	B	C	D	E	F
0	∅	▶	SP	0	H	P	'	p								
1	☺	◀	4	J	A	Q	a	q								
2	☺	↑	w	2	B	R	b	r								
3	♥	!!	J	3	C	S	c	s								
4	♦	†	#	4	D	T	d	t								
5	♣	§	%	5	E	U	e	u								
6	♠	_	&	6	F	V	f	v								
7	•	‡	'	7	G	W	g	w								
8	■	↑	{	8	H	X	h	x								
9	•	↓	}	9	I	Y	i	y								
A	■	→	*	:	J	Z	j	z								
B	♂	←	+	;	K	E	k	(
C	♀	⌊	~	■	L	\	l									
D	♪	↔	.	=	M]	m)								
E	♪	▲	.	■	N	^	n	~								
F	☼	▼	/	?	0	_	o	■								

Tally Dascom 1140

OCR-B character set 1

	0	1	2	3	4	5	6	7	8	9	A	B	C	D	E	F
0	NUL		SP	0	@	P	`	p	NUL							
1		DC1	!	1	A	Q	a	q		DC1						
2		DC2	"	2	B	R	b	r		DC2						
3		DC3	#	3	C	S	c	s		DC3						
4		DC4	\$	4	D	T	d	t		DC4						
5			%	5	E	U	e	u								
6			&	6	F	V	f	v								
7	BEL		'	7	G	W	g	w	BEL							
8	BS	CAN	(8	H	X	h	x	BS	CAN						
9	HT)	9	I	Y	i	y	HT							
A	LF		*	:	J	Z	j	z	LF							
B	VT	ESC	+	;	K	[k	{	VT	ESC						
C	FF	FS	,	<	L	\	l		FF	FS						
D	CR		-	=	M]	m	}	CR							
E	SO		.	>	N	^	n	~	SO							
F	SI		/	?	O	_	o	■	SI							

OCR-B character set 2

	0	1	2	3	4	5	6	7	8	9	A	B	C	D	E	F
0	∅	▶	SP	0	@	P	`	p								
1	☺	◀	!	1	A	Q	a	q								
2	☺	↕	"	2	B	R	b	r								
3	♥	!!	#	3	C	S	c	s								
4	♦	!\$	\$	4	D	T	d	t								
5	♣	\$%	%	5	E	U	e	u								
6	♠	-	&	6	F	V	f	v								
7	•	↑	'	7	G	W	g	w								
8	■	↑	(8	H	X	h	x								
9	•	↓)	9	I	Y	i	y								
A	■	→	*	:	J	Z	j	z								
B	♂	←	+	;	K	[k	{								
C	♀	└	,	<	L	\	l									
D	♪	↔	-	=	M]	m	}								
E	♪	▲	.	>	N	^	n	~								
F	☼	▼	/	?	O	_	o	■								

International Character Set Commands

Country	Basic Command
USA	<ESC>"R"CHR \$(0)
FRANCE	<ESC>"R"CHR \$(1)
GERMANY	<ESC>"R"CHR \$(2)
UK	<ESC>"R"CHR \$(3)
DENMARK 1	<ESC>"R"CHR \$(4)
SWEDEN	<ESC>"R"CHR \$(5)
ITALY	<ESC>"R"CHR \$(6)
SPAIN 1	<ESC>"R"CHR \$(7)
JAPAN	<ESC>"R"CHR \$(8)
NORWAY	<ESC>"R"CHR \$(9)
DENMARK 2	<ESC>"R"CHR \$(10)
SPAIN 2	<ESC>"R"CHR \$(11)
LATINAMERICA	<ESC>"R"CHR \$(12)
DENMARK/NORWAY	<ESC>"R"CHR \$(13)
CHINA	<ESC>"R"CHR \$(16)

International character sets

Character Code (Hex)												
Character Set	23	24	40	5B	5C	5D	5E	60	7B	7C	7D	7E
0: U. S. A.	#	\$	@	[\]	^	'	{		}	~
1: FRANCE	#	\$	à	°	ç	§	^	'	é	ù	è	"
2: GERMANY	#	\$	§	Ä	Ö	Ü	^	'	ä	ö	ü	ß
3: U. K.	£	\$	@	[\]	^	'	{		}	~
4: DENMARK 1	#	\$	@	Æ	Ø	Å	^	'	æ	Ø	å	~
5: SWEDEN	#	□	É	Ä	Ö	Å	Ü	é	ä	Ö	å	ü
6. ITALY	#	\$	@	°	\	é	^	ù	à	ò	è	ì
7. SPAIN 1	Pt	\$	@	ı	Ñ	¿	^	'	"	ñ	}	~
8. JAPAN	#	\$	@	ı	¥]	^	'	{		}	~
9: NORWAY	#	□	É	Æ	Ø	Å	Ü	é	æ	Ø	å	ü
10: DENMARK 2	#	\$	É	Æ	Ø	Å	Ü	é	æ	Ø	å	ü
11: SPAIN 2	#	\$	á	ı	Ñ	¿	é	'	ı	ñ	ó	ú
12: LATIN AMERICA	#	\$	á	ı	Ñ	¿	é	ü	ı	ñ	ó	ú
13: DENMARK/NORWAY	#	\$	@	[\]	^	'	{		}	~
16: CHINA	#	¥	@	[\]	^	'	{		}	~

11.2 Code Page Commands

Code Page	ESC R Parameter
CP 437	80
CP 737	93
CP 850	82
CP 851	88
CP 852	87
CP 857	8D
CP 858	9E
CP 860	84
CP 861	94
CP 863	85
CP 1252	72
CP 1253	73
CP 1254	74
8859-1	25
8859-1 (SAP)	2B
8859-2	26
8859-5	2A
8859-7	2D
8859-9	2E
8859-15	2F
Kamenicky	91
Mazovia	92
866 Bulgaria	9D
CP 1250	70
CP 1251	71
BRASCII	6D
Abicomp	6E
CP 865	86
CP 866	8E
CRO-ASCII	3C

11.3 Code Page Tables

CP 437

*	0	1	2	3	4	5	6	7	8	9	A	B	C	D	E	F
0	*			0	@	P	'	p	Ç	É	á	⋮	L	⊥	α	≡
1	*		!	1	A	Q	a	q	Û	æ	í	⋮	⊥	⊥	β	±
2	*		"	2	B	R	b	r	é	Æ	ó	⋮	⊥	⊥	Γ	≥
3	*		#	3	C	S	c	s	â	ö	ú	⋮	⊥	⊥	π	≤
4	*		\$	4	D	T	d	t	ä	ö	ñ	⋮	⊥	⊥	Σ	∩
5	*		%	5	E	U	e	u	à	ò	ñ	⋮	⊥	⊥	σ	∩
6	*		&	6	F	V	f	v	â	ó	ñ	⋮	⊥	⊥	μ	+
7	*		'	7	G	W	g	w	ç	ù	ó	⋮	⊥	⊥	τ	≈
8	*		(8	H	X	h	x	è	ÿ	ó	⋮	⊥	⊥	ϑ	°
9	*)	9	I	Y	i	y	ë	ÿ	ó	⋮	⊥	⊥	θ	·
A	*		*	:	J	Z	j	z	è	ÿ	ó	⋮	⊥	⊥	Ω	·
B	*		+	;	K	[k	{	í	φ	½	⋮	⊥	⊥	δ	∇
C	*		,	<	L	\	l		î	£	¼	⋮	⊥	⊥	ω	∇
D	*		-	=	M]	m	}	ï	¥	î	⋮	⊥	⊥	∅	∇
E	*		.	>	N	^	n	~	ä	℞	«	⋮	⊥	⊥	ε	∇
F	*		/	?	O	_	o		å	ƒ	»	⋮	⊥	⊥	∩	∇

CP 737

*	0	1	2	3	4	5	6	7	8	9	A	B	C	D	E	F
0	*			0	@	P	'	p	A	P	ι	⋮	L	⊥	ω	Ω
1	*		!	1	A	Q	a	q	B	Σ	κ	⋮	⊥	⊥	ά	±
2	*		"	2	B	R	b	r	Γ	T	α	⋮	⊥	⊥	έ	≥
3	*		#	3	C	S	c	s	Δ	Y	μ	⋮	⊥	⊥	ή	≤
4	*		\$	4	D	T	d	t	E	Φ	ν	⋮	⊥	⊥	ι	∩
5	*		%	5	E	U	e	u	Z	X	ε	⋮	⊥	⊥	ι	∩
6	*		&	6	F	V	f	v	H	Ψ	ο	⋮	⊥	⊥	ό	+
7	*		'	7	G	W	g	w	Θ	Ω	π	⋮	⊥	⊥	ύ	≈
8	*		(8	H	X	h	x	I	α	ρ	⋮	⊥	⊥	ύ	°
9	*)	9	I	Y	i	y	K	β	σ	⋮	⊥	⊥	ώ	·
A	*		*	:	J	Z	j	z	Λ	δ	ς	⋮	⊥	⊥	Α	·
B	*		+	;	K	[k	{	M	θ	τ	⋮	⊥	⊥	Ε	∇
C	*		,	<	L	\	l		N	ε	υ	⋮	⊥	⊥	H	∇
D	*		-	=	M]	m	}	Ξ	ζ	φ	⋮	⊥	⊥	I	∇
E	*		.	>	N	^	n	~	Ο	η	χ	⋮	⊥	⊥	O	∇
F	*		/	?	O	_	o		Π	θ	ψ	⋮	⊥	⊥	Y	∇

CP 850

	*	0	1	2	3	4	5	6	7	8	9	A	B	C	D	E	F
0	*				0	@	P	'	p	Ç	É	á	⋮	L	ð	ó	- ±
1	*		!	1	A	Q	a	q	ü	æ	í	⋮	⊥	⊥	⊥	⊥	⊥
2	*		"	2	B	R	b	r	é	Æ	ó	⋮	⊥	⊥	⊥	⊥	⊥
3	*		#	3	C	S	c	s	ä	ö	ú	⋮	⊥	⊥	⊥	⊥	⊥
4	*		\$	4	D	T	d	t	ä	ö	ñ	⋮	⊥	⊥	⊥	⊥	⊥
5	*		%	5	E	U	e	u	à	ò	ñ	⋮	⊥	⊥	⊥	⊥	⊥
6	*		&	6	F	V	f	v	ä	ö	o	⋮	⊥	⊥	⊥	⊥	⊥
7	*		'	7	G	W	g	w	ç	ù	o	⋮	⊥	⊥	⊥	⊥	⊥
8	*		(8	H	X	h	x	è	ý	í	⋮	⊥	⊥	⊥	⊥	⊥
9	*)	9	I	Y	i	y	ë	ö	í	⋮	⊥	⊥	⊥	⊥	⊥
A	*		*	:	J	Z	j	z	è	ü	í	⋮	⊥	⊥	⊥	⊥	⊥
B	*		+	;	K	[k	{	ï	ø	í	⋮	⊥	⊥	⊥	⊥	⊥
C	*		,	<	L	\	l		ï	£	¼	⋮	⊥	⊥	⊥	⊥	⊥
D	*		-	=	M]	m	}	ï	ø	í	⋮	⊥	⊥	⊥	⊥	⊥
E	*		.	>	N	^	n	~	ï	ä	x	⋮	⊥	⊥	⊥	⊥	⊥
F	*		/	?	O	_	o		ï	ä	f	⋮	⊥	⊥	⊥	⊥	⊥

CP 851

	*	0	1	2	3	4	5	6	7	8	9	A	B	C	D	E	F
0	*				0	@	P	'	p	Ç	I	ü	⋮	L	T	Z	- ±
1	*		!	1	A	Q	a	q	ü	ü	ü	⋮	⊥	⊥	⊥	⊥	⊥
2	*		"	2	B	R	b	r	é	o	ú	⋮	⊥	⊥	⊥	⊥	⊥
3	*		#	3	C	S	c	s	ä	ö	ú	⋮	⊥	⊥	⊥	⊥	⊥
4	*		\$	4	D	T	d	t	ä	ö	A	⋮	⊥	⊥	⊥	⊥	⊥
5	*		%	5	E	U	e	u	à	Y	B	⋮	⊥	⊥	⊥	⊥	⊥
6	*		&	6	F	V	f	v	A	ü	Γ	⋮	⊥	⊥	⊥	⊥	⊥
7	*		'	7	G	W	g	w	ç	ù	Δ	⋮	⊥	⊥	⊥	⊥	⊥
8	*		(8	H	X	h	x	è	Ω	E	⋮	⊥	⊥	⊥	⊥	⊥
9	*)	9	I	Y	i	y	ë	ö	Z	⋮	⊥	⊥	⊥	⊥	⊥
A	*		*	:	J	Z	j	z	è	ü	H	⋮	⊥	⊥	⊥	⊥	⊥
B	*		+	;	K	[k	{	ï	á	½	⋮	⊥	⊥	⊥	⊥	⊥
C	*		,	<	L	\	l		ï	£	θ	⋮	⊥	⊥	⊥	⊥	⊥
D	*		-	=	M]	m	}	ï	E	é	⋮	⊥	⊥	⊥	⊥	⊥
E	*		.	>	N	^	n	~	ï	ä	ñ	⋮	⊥	⊥	⊥	⊥	⊥
F	*		/	?	O	_	o		ï	ä	l	⋮	⊥	⊥	⊥	⊥	⊥

Tally Dascom 1140

CP 852

	*	0	1	2	3	4	5	6	7	8	9	A	B	C	D	E	F
0	*				0	@	P	`	p	Ç	É	á	⋮	L	đ	ó	-
1	*		!	1	A	Q	a	q	ç	ü	é	í	⋮	l	đ	ó	~
2	*		"	2	B	R	b	r	ç	ü	é	í	⋮	l	đ	ó	~
3	*		#	3	C	S	c	s	ç	ü	é	í	⋮	l	đ	ó	~
4	*		\$	4	D	T	d	t	ç	ü	é	í	⋮	l	đ	ó	~
5	*		%	5	E	U	e	u	ç	ü	é	í	⋮	l	đ	ó	~
6	*		&	6	F	V	f	v	ç	ü	é	í	⋮	l	đ	ó	~
7	*		'	7	G	W	g	w	ç	ü	é	í	⋮	l	đ	ó	~
8	*		(8	H	X	h	x	ç	ü	é	í	⋮	l	đ	ó	~
9	*)	9	I	Y	i	y	ç	ü	é	í	⋮	l	đ	ó	~
A	*		*	:	J	Z	j	z	ç	ü	é	í	⋮	l	đ	ó	~
B	*		+	;	K	[k	{	ç	ü	é	í	⋮	l	đ	ó	~
C	*		,	<	L	\	l		ç	ü	é	í	⋮	l	đ	ó	~
D	*		-	=	M]	m	}	ç	ü	é	í	⋮	l	đ	ó	~
E	*		.	>	N	^	n	~	ç	ü	é	í	⋮	l	đ	ó	~
F	*		/	?	O	_	o		ç	ü	é	í	⋮	l	đ	ó	~

CP 857

	*	0	1	2	3	4	5	6	7	8	9	A	B	C	D	E	F
0	*				0	@	P	`	p	Ç	É	á	⋮	L	Q	ó	-
1	*		!	1	A	Q	a	q	ç	ü	æ	í	⋮	l	Q	ó	±
2	*		"	2	B	R	b	r	ç	ü	æ	í	⋮	l	Q	ó	±
3	*		#	3	C	S	c	s	ç	ü	æ	í	⋮	l	Q	ó	±
4	*		\$	4	D	T	d	t	ç	ü	æ	í	⋮	l	Q	ó	±
5	*		%	5	E	U	e	u	ç	ü	æ	í	⋮	l	Q	ó	±
6	*		&	6	F	V	f	v	ç	ü	æ	í	⋮	l	Q	ó	±
7	*		'	7	G	W	g	w	ç	ü	æ	í	⋮	l	Q	ó	±
8	*		(8	H	X	h	x	ç	ü	æ	í	⋮	l	Q	ó	±
9	*)	9	I	Y	i	y	ç	ü	æ	í	⋮	l	Q	ó	±
A	*		*	:	J	Z	j	z	ç	ü	æ	í	⋮	l	Q	ó	±
B	*		+	;	K	[k	{	ç	ü	æ	í	⋮	l	Q	ó	±
C	*		,	<	L	\	l		ç	ü	æ	í	⋮	l	Q	ó	±
D	*		-	=	M]	m	}	ç	ü	æ	í	⋮	l	Q	ó	±
E	*		.	>	N	^	n	~	ç	ü	æ	í	⋮	l	Q	ó	±
F	*		/	?	O	_	o		ç	ü	æ	í	⋮	l	Q	ó	±

Tally Dascom 1140

CP 858

*	0	1	2	3	4	5	6	7	8	9	A	B	C	D	E	F
0 *				0	@	P	'	p	Ç	É	á	⋯	L	ð	ó	-
1 *		!		1	A	Q	a	q	Ü	æ	í	⋮	l	Ð	ö	±
2 *		"		2	B	R	b	r	é	Æ	ó	⋮	T	È	ò	≡
3 *		#		3	C	S	c	s	ä	Ö	ú	⋮	⊥	É	õ	¼
4 *		\$		4	D	T	d	t	ä	ö	ñ	⋮	⊥	È	ö	q
5 *		%		5	E	U	e	u	à	ò	ñ	⋮	⊥	É	ö	s
6 *		&		6	F	V	f	v	á	ó	æ	⋮	⊥	È	µ	+
7 *		'		7	G	W	g	w	ç	ù	o	⋮	⊥	È	µ	∩
8 *		(8	H	X	h	x	è	ÿ	í	⋮	⊥	È	µ	∩
9 *)		9	I	Y	i	y	è	ÿ	ó	⋮	⊥	È	µ	∩
A *		*		:	J	Z	j	z	è	ÿ	ó	⋮	⊥	È	µ	∩
B *		+		;	K	[k	{	í	ø	½	⋮	⊥	È	µ	∩
C *		,		<	L	\	l		í	ø	¼	⋮	⊥	È	µ	∩
D *		-		=	M]	m	}	í	ø	¼	⋮	⊥	È	µ	∩
E *		.		>	N	^	n	~	í	ø	¼	⋮	⊥	È	µ	∩
F *		/		?	O	_	o	~	í	ø	¼	⋮	⊥	È	µ	∩

CP 860

*	0	1	2	3	4	5	6	7	8	9	A	B	C	D	E	F
0 *				0	@	P	'	p	Ç	É	á	⋯	L	ll	α	≡
1 *		!		1	A	Q	a	q	Ü	À	í	⋮	l	ll	β	±
2 *		"		2	B	R	b	r	é	È	ó	⋮	T	ll	Γ	±
3 *		#		3	C	S	c	s	ä	Ö	ú	⋮	⊥	ll	Π	±
4 *		\$		4	D	T	d	t	ä	ö	ñ	⋮	⊥	ll	Σ	±
5 *		%		5	E	U	e	u	à	ò	ñ	⋮	⊥	ll	σ	±
6 *		&		6	F	V	f	v	á	ó	æ	⋮	⊥	ll	μ	+
7 *		'		7	G	W	g	w	ç	ù	o	⋮	⊥	ll	τ	±
8 *		(8	H	X	h	x	è	ÿ	í	⋮	⊥	ll	ϕ	±
9 *)		9	I	Y	i	y	è	ÿ	ó	⋮	⊥	ll	ϕ	±
A *		*		:	J	Z	j	z	è	ÿ	ó	⋮	⊥	ll	Ω	±
B *		+		;	K	[k	{	í	ø	½	⋮	⊥	ll	δ	±
C *		,		<	L	\	l		í	ø	¼	⋮	⊥	ll	δ	±
D *		-		=	M]	m	}	í	ø	¼	⋮	⊥	ll	δ	±
E *		.		>	N	^	n	~	í	ø	¼	⋮	⊥	ll	ε	±
F *		/		?	O	_	o	~	í	ø	¼	⋮	⊥	ll	ε	±

Tally Dascom 1140

CP 861

	*	0	1	2	3	4	5	6	7	8	9	A	B	C	D	E	F
0	*				0	@	P	'	p	Ç	É	á	⋮	L	⋮	α	≡
1	*		!	1	A	Q	a	q	ü	é	æ	í	⋮	l	⋮	β	±
2	*		"	2	B	R	b	r	é	Æ	ó	⋮	l	⋮	Γ	π	≤
3	*		#	3	C	S	c	s	ä	ö	ú	⋮	l	⋮	Π	∞	≤
4	*		\$	4	D	T	d	t	ä	ö	á	⋮	l	⋮	Σ	∞	∞
5	*		%	5	E	U	e	u	à	ö	í	⋮	l	⋮	σ	∞	∞
6	*		&	6	F	V	f	v	ä	ö	ó	⋮	l	⋮	μ	∞	∞
7	*		'	7	G	W	g	w	ç	ý	ó	⋮	l	⋮	τ	∞	∞
8	*		(8	H	X	h	x	ë	ý	ü	⋮	l	⋮	θ	∞	∞
9	*)	9	I	Y	i	y	ë	ü	ü	⋮	l	⋮	Θ	∞	∞
A	*		*	:	J	Z	j	z	è	ü	ü	⋮	l	⋮	Ω	∞	∞
B	*		+	;	K	[k	{	è	ø	½	⋮	l	⋮	δ	∞	∞
C	*		,	<	L	\	l		è	ø	¼	⋮	l	⋮	ω	∞	∞
D	*		-	=	M]	m	}	è	ø	¼	⋮	l	⋮	∞	∞	∞
E	*		.	>	N	^	n	~	è	ø	¼	⋮	l	⋮	∞	∞	∞
F	*		/	?	O	_	o		è	ø	¼	⋮	l	⋮	∞	∞	∞

CP 863

	*	0	1	2	3	4	5	6	7	8	9	A	B	C	D	E	F
0	*				0	@	P	'	p	Ç	É	!	⋮	L	⋮	α	≡
1	*		!	1	A	Q	a	q	ü	é	è	'	⋮	l	⋮	β	±
2	*		"	2	B	R	b	r	é	è	ó	⋮	l	⋮	Γ	π	≤
3	*		#	3	C	S	c	s	ä	ö	ú	⋮	l	⋮	Π	∞	≤
4	*		\$	4	D	T	d	t	ä	ö	"	⋮	l	⋮	Σ	∞	∞
5	*		%	5	E	U	e	u	à	ö	ü	⋮	l	⋮	σ	∞	∞
6	*		&	6	F	V	f	v	ä	ö	ü	⋮	l	⋮	μ	∞	∞
7	*		'	7	G	W	g	w	ç	ý	ü	⋮	l	⋮	τ	∞	∞
8	*		(8	H	X	h	x	ë	ü	ü	⋮	l	⋮	θ	∞	∞
9	*)	9	I	Y	i	y	ë	ü	ü	⋮	l	⋮	Θ	∞	∞
A	*		*	:	J	Z	j	z	è	ü	ü	⋮	l	⋮	Ω	∞	∞
B	*		+	;	K	[k	{	è	ø	½	⋮	l	⋮	δ	∞	∞
C	*		,	<	L	\	l		è	ø	¼	⋮	l	⋮	ω	∞	∞
D	*		-	=	M]	m	}	è	ø	¼	⋮	l	⋮	∞	∞	∞
E	*		.	>	N	^	n	~	è	ø	¼	⋮	l	⋮	∞	∞	∞
F	*		/	?	O	_	o		è	ø	¼	⋮	l	⋮	∞	∞	∞

Tally Dascom 1140

CP 1252

	*	0	1	2	3	4	5	6	7	8	9	A	B	C	D	E	F
0	*				0	@	P	`	p	€			°	À	Ð	à	ð
1	*		!		1	A	Q	a	q		`	ı	±	Á	Ñ	á	ñ
2	*		"		2	B	R	b	r	,	'	φ	²	Â	Ò	â	ò
3	*		#		3	C	S	c	s	f	"	£	³	Ã	Ó	ã	ó
4	*		\$		4	D	T	d	t	"	"	¤	'	Ä	Ô	ä	ô
5	*		%		5	E	U	e	u	"	•	¥	μ	Å	Ö	å	ö
6	*		&		6	F	V	f	v	f	-	!	¶	Æ	Ø	æ	ø
7	*		'		7	G	W	g	w	‡	—	§	•	Ç	×	ç	×
8	*		(8	H	X	h	x	^	~	"	ˆ	È	Ø	è	ø
9	*)		9	I	Y	i	y	%	™	@	ˆ	É	Ù	é	ù
A	*		*		:	J	Z	j	z	§	™	@	ˆ	Ê	Ú	ê	ú
B	*		+		;	K	[k	{	<	>	«	»	Ë	Û	ë	û
C	*		,		<	L	\	l		œ	œ	¬	¼	Ì	Ü	ì	ü
D	*		-		=	M]	m	}			—	½	Í	Ý	í	ý
E	*		.		>	N	^	n	~	ž	ž	@	¾	Î	Þ	î	þ
F	*		/		?	O	_	o		ž	ž	—	¿	Ï	Û	ï	Û

CP 1253

	*	0	1	2	3	4	5	6	7	8	9	A	B	C	D	E	F
0	*				0	@	P	`	p	€			°	Û	Π	ü	π
1	*		!		1	A	Q	a	q		`	ˆ	±	A	P	α	ρ
2	*		"		2	B	R	b	r	,	'	ˆ	²	B		β	σ
3	*		#		3	C	S	c	s	f	"	£	³	Γ	Σ	γ	σ
4	*		\$		4	D	T	d	t	"	"	¤	'	Δ	T	θ	τ
5	*		%		5	E	U	e	u	"	•	¥	μ	E	Y	ε	υ
6	*		&		6	F	V	f	v	f	-	!	¶	Z	Φ	ζ	φ
7	*		'		7	G	W	g	w	‡	—	§	•	H	X	η	χ
8	*		(8	H	X	h	x			"	E	Θ	Ψ	θ	ψ
9	*)		9	I	Y	i	y	%	™	@	ˆ	H	I	Ω	ι
A	*		*		:	J	Z	j	z	§	™	@	ˆ	I	K	ı	κ
B	*		+		;	K	[k	{	<	>	«	»	Λ	Υ	λ	υ
C	*		,		<	L	\	l				¬	ˆ	M	α	μ	
D	*		-		=	M]	m	}			—	½	N	é	ν	
E	*		.		>	N	^	n	~			@	¾	Y	ή	ε	
F	*		/		?	O	_	o				—	¿	Ω	ι	ο	

Tally Dascom 1140

CP 1254

	*	0	1	2	3	4	5	6	7	8	9	A	B	C	D	E	F
0	*			0	@	P	`	p	€			°	À	Ë	à	ë	
1	*		!	1	A	Q	a	q		´	ı	±	Á	Ï	á	ï	
2	*		"	2	B	R	b	r	,	´	¢	²	Â	Ò	â	ò	
3	*		#	3	C	S	c	s	,	“	£	³	Ã	Ó	ã	ó	
4	*		\$	4	D	T	d	t	„	”	¤	´	Ä	Ô	ä	ô	
5	*		%	5	E	U	e	u	…	•	¥	µ	Å	Ö	å	ö	
6	*		&	6	F	V	f	v	†	—	¦	¶	Æ	Ø	æ	ø	
7	*		'	7	G	W	g	w	‡	—	§	·	Ç	×	ç	÷	
8	*		(8	H	X	h	x	^	~	¨	¸	È	Ø	è	ø	
9	*)	9	I	Y	i	y	%	™	©	¹	É	Ù	é	ù	
A	*		*	:	J	Z	j	z	§	§	®	º	Ê	Ú	ê	ú	
B	*		+	;	K	[k	{	<	>	«	»	Ë	Û	ë	û	
C	*		,	<	L	\	l		€	œ	¬	¼	Ì	Ü	ì	ü	
D	*		-	=	M]	m	}			—	½	Í	Ý	í	ý	
E	*		.	>	N	^	n	~			®	¾	Î	ÿ	î	ÿ	
F	*		/	?	O	_	o			ÿ	—	¿	Ï	ß	ï	ÿ	

8859-1

	*	0	1	2	3	4	5	6	7	8	9	A	B	C	D	E	F
0	*			0	@	P	`	p	Ç	É		°	À	Ð	à	ð	
1	*		!	1	A	Q	a	q	Ü	æ	ı	±	Á	Ñ	á	ñ	
2	*		"	2	B	R	b	r	é	œ	¢	²	Â	Ò	â	ò	
3	*		#	3	C	S	c	s	ä	ö	£	³	Ã	Ó	ã	ó	
4	*		\$	4	D	T	d	t	ä	ö	¤	´	Ä	Ô	ä	ô	
5	*		%	5	E	U	e	u	à	ò	¥	µ	Å	Ö	å	ö	
6	*		&	6	F	V	f	v	ä	ö	¦	¶	Æ	Ø	æ	ø	
7	*		'	7	G	W	g	w	Ç	Ù	§	·	Ç	×	ç	÷	
8	*		(8	H	X	h	x	è	ÿ	¨	¸	È	Ø	è	ø	
9	*)	9	I	Y	i	y	è	Û	©	¹	É	Ù	é	ù	
A	*		*	:	J	Z	j	z	è	Ü	®	º	Ê	Ú	ê	ú	
B	*		+	;	K	[k	{	ı	¢	«	»	Ë	Û	ë	û	
C	*		,	<	L	\	l		ı	£	¬	¼	Ì	Ü	ì	ü	
D	*		-	=	M]	m	}	ı	¥	—	½	Í	Ý	í	ý	
E	*		.	>	N	^	n	~	ı	Æ	®	¾	Î	ÿ	î	ÿ	
F	*		/	?	O	_	o		ı	ƒ	—	¿	Ï	ß	ï	ÿ	

Tally Dascom 1140

8859-1 (SAP)

	*	0	1	2	3	4	5	6	7	8	9	A	B	C	D	E	F
0	*				0	@	P	`	p	Ç	†	°	À	Ð	à	ð	
1	*		!	1	A	Q	a	q	ü	—	ı	±	Á	Ñ	á	ñ	
2	*		"	2	B	R	b	r	é	—	ı	²	Â	Ò	â	ò	
3	*		#	3	C	S	c	s	ë	—	ı	³	Ã	Ó	ã	ó	
4	*		\$	4	D	T	d	t	ä	—	ı	´	Ä	Ô	ä	ô	
5	*		%	5	E	U	e	u	à	—	ı	µ	Å	Ö	å	ö	
6	*		&	6	F	V	f	v	ä	—	ı	¶	Æ	Ø	æ	ø	
7	*		'	7	G	W	g	w	ç	—	ı	·	Ç	×	ç	×	
8	*		(8	H	X	h	x	ë	—	ı	¸	È	Ø	è	ø	
9	*)	9	I	Y	i	y	ë	—	ı	¹	É	Ù	é	ù	
A	*		*	:	J	Z	j	z	è	—	ı	º	Ê	Ú	è	ú	
B	*		+	;	K	[k	{	ì	—	ı	»	Ë	Û	ë	û	
C	*		,	<	L	\	l		í	—	ı	¼	Ì	Ü	ì	ü	
D	*		-	=	M]	m	}	î	—	ı	½	Í	Ý	í	ý	
E	*		.	>	N	^	n	~	ï	—	ı	¾	Î	ÿ	ï	ÿ	
F	*		/	?	O	_	o		ä	—	ı	¿	Ï	ß	ï	ÿ	

8859-2

	*	0	1	2	3	4	5	6	7	8	9	A	B	C	D	E	F
0	*				0	@	P	`	p	Ç	É	°	À	Ð	á	ð	
1	*		!	1	A	Q	a	q	Ü	æ	æ	±	Á	Ñ	á	ñ	
2	*		"	2	B	R	b	r	é	æ	æ	²	Â	Ò	â	ò	
3	*		#	3	C	S	c	s	ë	ö	ö	³	Ã	Ó	ã	ó	
4	*		\$	4	D	T	d	t	ä	ö	ö	´	Ä	Ô	ä	ô	
5	*		%	5	E	U	e	u	à	ö	ö	µ	Å	Ö	å	ö	
6	*		&	6	F	V	f	v	ä	ö	ö	¶	Æ	Ø	æ	ø	
7	*		'	7	G	W	g	w	ç	ú	ö	·	Ç	×	ç	×	
8	*		(8	H	X	h	x	ë	ý	ö	¸	È	Ø	è	ø	
9	*)	9	I	Y	i	y	ë	ö	ö	¹	É	Ù	é	ù	
A	*		*	:	J	Z	j	z	è	ü	ö	º	Ê	Ú	è	ú	
B	*		+	;	K	[k	{	ì	ü	ö	»	Ë	Û	ë	û	
C	*		,	<	L	\	l		í	ü	ö	¼	Ì	Ü	ì	ü	
D	*		-	=	M]	m	}	î	ü	ö	½	Í	Ý	í	ý	
E	*		.	>	N	^	n	~	ï	ü	ö	¾	Î	ÿ	ï	ÿ	
F	*		/	?	O	_	o		ä	ü	ö	¿	Ï	ß	ï	ÿ	

Tally Dascom 1140

8859-5

* 0 1 2 3 4 5 6 7 8 9 A B C D E F

0 * 0 @ P ` p Ç É Á Р а р №
1 * ! 1 A Q a q Ü æ È В С б с ё ё
2 * " 2 B R b r é æ Ъ В Т в т ъ ъ
3 * # 3 C S c s ä ö Ѓ Г У г у ѓ ѓ
4 * \$ 4 D T d t ä ö È Д Ф д ф е е
5 * % 5 E U e u à ò S Е Х е х с с
6 * & 6 F V f v ä ö I Ж Ц ж ц і і
7 * ' 7 G W g w ç ù İ З Ч э ч і і
8 * (8 H X h x ē ŷ Ĵ И Ш и ш ј ј
9 *) 9 I Y i y è ü Ъ Й Щ й щ њ њ
A * * : J Z j z è ü Ъ К Ь к њ њ њ њ
B * + ; K [k { i í Ĥ Л Ы л њ њ њ њ
C * , < L \ l i ĩ £ Ķ М Ъ м њ њ њ њ
D * - = M] m } i ÿ Ÿ - Н Э н э њ њ
E * . > N ^ n ~ Ħ Ğ Ÿ Ю ю ю ю њ њ
F * / ? O _ o A f U П Я п я њ њ

8859-7

* 0 1 2 3 4 5 6 7 8 9 A B C D E F

0 * 0 @ P ` p Ç É ° ù П ù п р
1 * ! 1 A Q a q Ü æ ' ± A Р α ρ ρ ρ
2 * " 2 B R b r é æ ` ² В Р β ρ ρ ρ
3 * # 3 C S c s ä ö £ ³ Г Σ ρ σ τ
4 * \$ 4 D T d t ä ö ' Δ Т δ τ τ τ τ
5 * % 5 E U e u à ò " E Υ ε υ φ φ
6 * & 6 F V f v ä ö ! A Z Ф ζ φ φ φ
7 * ' 7 G W g w ç ù S • Н Х η χ ψ ψ
8 * (8 H X h x ē ŷ " E Θ Ψ θ ψ ω ω
9 *) 9 I Y i y è ü © Н I Ω ι κ ω њ њ
A * * : J Z j z è ü I K İ к њ њ њ њ
B * + ; K [k { i í « » Л Ы л њ њ њ њ
C * , < L \ l i ĩ £ Ķ О М Я њ њ њ њ
D * - = M] m } i ÿ Ÿ - ½ N é é њ њ
E * . > N ^ n ~ Ħ Ğ Ÿ Ю ю ю ю њ њ
F * / ? O _ o A f U П Я п я њ њ

Tally Dascom 1140

8859-9

	*	0	1	2	3	4	5	6	7	8	9	A	B	C	D	E	F
0	*				0	@	P	`	p	Ç	É		°	À	Ð	à	ð
1	*		!	1	A	Q	a	q	Û	æ	í	±	Á	Ñ	á	ñ	
2	*		"	2	B	R	b	r	é	Æ	φ	²	Â	Ò	â	ò	
3	*		#	3	C	S	c	s	ä	Ö	£	³	Ã	Ó	ã	ó	
4	*		\$	4	D	T	d	t	ä	ö	¤	'	Ä	Ô	ä	ô	
5	*		%	5	E	U	e	u	à	ò	¥	µ	Å	Ö	ä	ö	
6	*		&	6	F	V	f	v	ä	ü	¦	¶	Æ	Ü	æ	ü	
7	*		'	7	G	W	g	w	Ç	Ù	§	·	Ç	×	ç	÷	
8	*		(8	H	X	h	x	ë	ÿ	¨	¸	È	Ø	è	ø	
9	*)	9	I	Y	i	y	ë	ÿ	©	¹	É	Ù	é	ù	
A	*		*	:	J	Z	j	z	è	ü	®	º	Ê	Ú	ê	ú	
B	*		+	;	K	[k	{	ï	φ	«	»	Ë	Û	ë	ü	
C	*		,	<	L	\	l		î	£	¬	¼	Ì	Ü	ì	ü	
D	*		-	=	M]	m	}	ï	¥	-	½	Í	Ý	í	ý	
E	*		.	>	N	^	n	~	Ï	₹	®	¾	Î	ÿ	ï	ÿ	
F	*		/	?	O	_	o		À	f	—	¿	Ï	ß	ï	ÿ	

8859-15

	*	0	1	2	3	4	5	6	7	8	9	A	B	C	D	E	F
0	*				0	@	P	`	p	Ç	É		°	À	Ð	à	ð
1	*		!	1	A	Q	a	q	Û	æ	í	±	Á	Ñ	á	ñ	
2	*		"	2	B	R	b	r	é	Æ	φ	²	Â	Ò	â	ò	
3	*		#	3	C	S	c	s	ä	Ö	£	³	Ã	Ó	ã	ó	
4	*		\$	4	D	T	d	t	ä	ö	¤	´	Ä	Ô	ä	ô	
5	*		%	5	E	U	e	u	à	ò	¥	µ	Å	Ö	ä	ö	
6	*		&	6	F	V	f	v	ä	ü	¦	¶	Æ	Ü	æ	ü	
7	*		'	7	G	W	g	w	Ç	Ù	§	·	Ç	×	ç	÷	
8	*		(8	H	X	h	x	ë	ÿ	¨	¸	È	Ø	è	ø	
9	*)	9	I	Y	i	y	ë	ÿ	©	¹	É	Ù	é	ù	
A	*		*	:	J	Z	j	z	è	ü	®	º	Ê	Ú	ê	ú	
B	*		+	;	K	[k	{	ï	φ	«	»	Ë	Û	ë	ü	
C	*		,	<	L	\	l		î	£	¬	¼	Ì	Ü	ì	ü	
D	*		-	=	M]	m	}	ï	¥	-	½	Í	Ý	í	ý	
E	*		.	>	N	^	n	~	Ï	₹	®	¾	Î	ÿ	ï	ÿ	
F	*		/	?	O	_	o		À	f	—	¿	Ï	ß	ï	ÿ	

Tally Dascom 1140

Kamenicky

	*	0	1	2	3	4	5	6	7	8	9	A	B	C	D	E	F
0	*				0	@	P	`	p	č	é	á	⋯	L	ll	α	≡
1	*		!		1	A	Q	a	q	ü	ž	í	⋮	⊥	⊥	β	±
2	*		"		2	B	R	b	r	é	ž	ó	⋮	⊥	⊥	Γ	∑
3	*		#		3	C	S	c	s	ď	ō	ú	⋮	⊥	⊥	π	∞
4	*		\$		4	D	T	d	t	ä	ö	ň	⋮	⊥	⊥	Σ	∞
5	*		%		5	E	U	e	u	ď	ó	ň	⋮	⊥	⊥	σ	∞
6	*		&		6	F	V	f	v	ť	ō	ň	⋮	⊥	⊥	μ	∞
7	*		'		7	G	W	g	w	č	ü	š	⋮	⊥	⊥	τ	∞
8	*		(8	H	X	h	x	ě	y	š	⋮	⊥	⊥	ϕ	∞
9	*)		9	I	Y	i	y	ě	ö	ř	⋮	⊥	⊥	θ	∞
A	*		*	:	J	Z	j	z	l	ü	ř	⋮	⊥	⊥	Ω	∞	
B	*		+	;	K	[k	{	l	í	š	⋮	⊥	⊥	δ	∞	
C	*		,	<	L	\	l		l	l	¼	⋮	⊥	⊥	∞	∞	
D	*		-	=	M]	m	}	l	ý	š	⋮	⊥	⊥	∞	∞	
E	*		.	>	N	^	n	~	l	ř	«	⋮	⊥	⊥	∞	∞	
F	*		/	?	O	_	o		l	ř	»	⋮	⊥	⊥	∞	∞	

Mazovia

	*	0	1	2	3	4	5	6	7	8	9	A	B	C	D	E	F
0	*				0	@	P	`	p	ç	é	ž	⋯	L	ll	α	≡
1	*		!		1	A	Q	a	q	ü	ē	ž	⋮	⊥	⊥	β	±
2	*		"		2	B	R	b	r	é	ł	ó	⋮	⊥	⊥	Γ	∑
3	*		#		3	C	S	c	s	ä	ō	ó	⋮	⊥	⊥	π	∞
4	*		\$		4	D	T	d	t	ä	ö	ń	⋮	⊥	⊥	Σ	∞
5	*		%		5	E	U	e	u	ä	ć	ń	⋮	⊥	⊥	σ	∞
6	*		&		6	F	V	f	v	ę	ū	ż	⋮	⊥	⊥	μ	∞
7	*		'		7	G	W	g	w	ç	ù	ż	⋮	⊥	⊥	τ	∞
8	*		(8	H	X	h	x	ę	ś	ł	⋮	⊥	⊥	ϕ	∞
9	*)		9	I	Y	i	y	ę	ö	ł	⋮	⊥	⊥	θ	∞
A	*		*	:	J	Z	j	z	l	ü	ł	⋮	⊥	⊥	Ω	∞	
B	*		+	;	K	[k	{	l	í	ł	½	⋮	⊥	⊥	δ	∞
C	*		,	<	L	\	l		l	l	¼	⋮	⊥	⊥	∞	∞	
D	*		-	=	M]	m	}	l	ć	ł	¼	⋮	⊥	⊥	∞	∞
E	*		.	>	N	^	n	~	l	ř	«	⋮	⊥	⊥	∞	∞	
F	*		/	?	O	_	o		l	ř	»	⋮	⊥	⊥	∞	∞	

Tally Dascom 1140

866 Bulgaria

*	0	1	2	3	4	5	6	7	8	9	A	B	C	D	E	F
0 *			0	@	P	`	p	А	Р	а	р	Л	⋮	α	≡	
1 *		!	1	А	Q	а	q	Б	С	б	с	⊥	⋮	β	±	
2 *		"	2	В	R	в	r	В	Т	в	т	⊥	⋮	Γ	≥	
3 *		#	3	С	S	с	s	Г	У	г	у	⊥	⋮	π	≤	
4 *		\$	4	D	T	d	t	Д	Ф	д	ф	⊥	⋮	Σ	∫	
5 *		%	5	E	U	e	u	Е	Х	е	х	⊥	⋮	σ	∫	
6 *		&	6	F	V	f	v	Ж	Ц	ж	ц	⊥	⋮	μ	+ ≈	
7 *		'	7	G	W	g	w	З	Ч	з	ч	⊥	⋮	τ	≈	
8 *		(8	H	X	h	x	И	Ш	и	ш	⊥	⋮	ϕ	°	
9 *)	9	I	Y	i	y	Й	Щ	й	щ	⊥	⋮	θ	·	
A *		*	:	J	Z	j	z	К	Ъ	к	ъ	⊥	⋮	Ω	·	
B *		+	;	K	[k	{	Л	Ы	л	ы	⊥	⋮	δ	√	
C *		,	<	L	\	l		М	Ь	м	ь	⊥	⋮	∞	π	
D *		-	=	M]	m	}	Н	Э	н	э	⊥	⋮	∅	2	
E *		.	>	N	^	n	~	О	Ю	о	ю	⊥	⋮	∅	ε	
F *		/	?	O	_	o		П	Я	п	я	⊥	⋮	∅	∅	

CP 1250

*	0	1	2	3	4	5	6	7	8	9	A	B	C	D	E	F
0 *			0	@	P	`	p	€			°	°	°	°	°	°
1 *		!	1	А	Q	а	q	˘	˘	˘	±	°	°	°	°	°
2 *		"	2	В	R	в	r	˘	˘	˘	˘	°	°	°	°	°
3 *		#	3	С	S	с	s	˘	˘	˘	˘	°	°	°	°	°
4 *		\$	4	D	T	d	t	˘	˘	˘	˘	°	°	°	°	°
5 *		%	5	E	U	e	u	˘	˘	˘	˘	°	°	°	°	°
6 *		&	6	F	V	f	v	˘	˘	˘	˘	°	°	°	°	°
7 *		'	7	G	W	g	w	˘	˘	˘	˘	°	°	°	°	°
8 *		(8	H	X	h	x	˘	˘	˘	˘	°	°	°	°	°
9 *)	9	I	Y	i	y	˘	˘	˘	˘	°	°	°	°	°
A *		*	:	J	Z	j	z	˘	˘	˘	˘	°	°	°	°	°
B *		+	;	K	[k	{	˘	˘	˘	˘	°	°	°	°	°
C *		,	<	L	\	l		˘	˘	˘	˘	°	°	°	°	°
D *		-	=	M]	m	}	˘	˘	˘	˘	°	°	°	°	°
E *		.	>	N	^	n	~	˘	˘	˘	˘	°	°	°	°	°
F *		/	?	O	_	o		˘	˘	˘	˘	°	°	°	°	°

CP 1251

*	0	1	2	3	4	5	6	7	8	9	A	B	C	D	E	F
0 *				0	@	P	`	p	Ђ	ђ		°	А	Р	а	р
1 *		!	1	A	Q	a	q	ѓ	ђ	Ў	±	В	С	б	с	т
2 *		"	2	B	R	b	r	ј	‘	Ў	І	В	Т	в	т	у
3 *		#	3	C	S	c	s	ђ	"	Ј	і	Г	У	г	у	ф
4 *		\$	4	D	T	d	t	„	”	Љ	г	Д	Ф	д	ф	х
5 *		%	5	E	U	e	u	…	•	Г	μ	Е	Х	е	х	ц
6 *		&	6	F	V	f	v	†	-	;	q	Ж	Ц	ж	ц	ч
7 *		'	7	G	W	g	w	‡	—	Š	•	З	Ч	з	ч	щ
8 *		(8	H	X	h	x	€		Ё	ё	И	Ш	и	ш	щ
9 *)	9	I	Y	i	y	‰	™	©	®	Й	Щ	й	щ	ъ
A *		*	:	J	Z	j	z	Ђ	Ђ	Є	є	К	Ъ	к	ъ	ы
B *		+	;	K	[k	{	<	>	«	»	Л	М	л	м	ь
C *		,	<	L	\	l		Ђ	Ђ	Г	Г	М	Ь	м	ь	э
D *		-	=	M]	m	}	К	К	—	—	С	Н	э	н	о
E *		.	>	N	^	n	~	Н	Н	®	®	О	Ю	о	ю	я
F *		/	?	O	_	o		Ц	Ц	İ	İ	П	Я	п	я	

BRASCI

*	0	1	2	3	4	5	6	7	8	9	A	B	C	D	E	F
0 *				0	@	P	`	p			°	À	Đ	à	ǎ	ǎ
1 *		!	1	A	Q	a	q			ı	±	Á	Ñ	á	ñ	ñ
2 *		"	2	B	R	b	r			ф	²	Â	Ò	â	ò	ò
3 *		#	3	C	S	c	s			£	³	Ã	Ó	ã	ó	ó
4 *		\$	4	D	T	d	t			¤	´	Ä	Ô	ä	ô	ô
5 *		%	5	E	U	e	u			¥	µ	Å	Ö	å	ö	ö
6 *		&	6	F	V	f	v			;	¶	Æ	Ü	æ	ü	ü
7 *		'	7	G	W	g	w			Š	•	Ç	Œ	ç	œ	œ
8 *		(8	H	X	h	x			”	ˆ	È	Ø	è	ø	ø
9 *)	9	I	Y	i	y			©	¹	É	Ù	é	ù	ù
A *		*	:	J	Z	j	z			ª	º	Ê	Ú	ê	ú	ú
B *		+	;	K	[k	{			«	»	Ë	Û	ë	û	û
C *		,	<	L	\	l				Г	¼	İ	Ü	ı	ü	ü
D *		-	=	M]	m	}			—	½	İ	Ý	ı	ý	ý
E *		.	>	N	^	n	~			®	¾	İ	Р	ı	р	р
F *		/	?	O	_	o				—	¿	İ	В	ı	в	в

Abicomp

	*	0	1	2	3	4	5	6	7	8	9	A	B	C	D	E	F

0	*				0	@	P	`	p				ò	ì	ò		
1	*		!		1	A	Q	a	q			À	Ó	à	ó		
2	*		"		2	B	R	b	r			Á	Ô	á	ô		
3	*		#		3	C	S	c	s			Â	Ï	â	ï		
4	*		\$		4	D	T	d	t			Ã	Ö	ã	ö		
5	*		%		5	E	U	e	u			Ä	Ø	ä	ø		
6	*		&		6	F	V	f	v			Ç	Ù	ç	ù		
7	*		'		7	G	W	g	w			È	Ú	è	ú		
8	*		(8	H	X	h	x			É	Û	é	û		
9	*)		9	I	Y	i	y			Ê	Ü	ê	ü		
A	*		*	:	J	Z	j	z	{			Ë	Ý	ë	ý		
B	*		+	;	K	[k	{				Ì	”	ì	”	ß	
C	*		,	<	L	\	l		}			Í	£	í	£	ø	
D	*		-	=	M]	m	}	~			Î	•	î	•	ø	
E	*		.	>	N	^	n	~				Ï	ø	ï	ø	¿	
F	*		/	?	O	_	o					Ñ	°	ñ	°	±	

CP 865

	*	0	1	2	3	4	5	6	7	8	9	A	B	C	D	E	F

0	*				0	@	P	`	p	Ç	É	á	⋮	L	⋮	α	≡
1	*		!		1	A	Q	a	q	Û	æ	í	⋮	⊥	⊥	β	±
2	*		"		2	B	R	b	r	é	Æ	ó	⋮	⊥	⊥	Γ	≤
3	*		#		3	C	S	c	s	ä	Ö	ú	⋮	⊥	⊥	Π	≤
4	*		\$		4	D	T	d	t	ä	ö	ñ	⋮	⊥	⊥	Σ	⋮
5	*		%		5	E	U	e	u	Ä	Ø	ò	⋮	⊥	⊥	σ	⋮
6	*		&		6	F	V	f	v	ä	ø	ü	⋮	⊥	⊥	μ	÷
7	*		'		7	G	W	g	w	ç	Û	ÿ	⋮	⊥	⊥	τ	≈
8	*		(8	H	X	h	x	e	Û	ÿ	⋮	⊥	⊥	ϕ	°
9	*)		9	I	Y	i	y	è	Ü	ÿ	⋮	⊥	⊥	Θ	•
A	*		*	:	J	Z	j	z	{	è	Ü	ÿ	⋮	⊥	⊥	Ω	•
B	*		+	;	K	[k	{		ï	Ø	½	⋮	⊥	⊥	δ	•
C	*		,	<	L	\	l		}	ī	£	¼	⋮	⊥	⊥	ω	•
D	*		-	=	M]	m	}	~	î	ø	¼	⋮	⊥	⊥	ø	•
E	*		.	>	N	^	n	~		Ĥ	ø	¼	⋮	⊥	⊥	ε	•
F	*		/	?	O	_	o			Ĥ	ø	¼	⋮	⊥	⊥	π	•

CP 866

	*	0	1	2	3	4	5	6	7	8	9	A	B	C	D	E	F
0	*				0	@	P	`	p	А	Р	а	б	Л	л	р	ё
1	*		!	1	A	Q	a	q	В	С	б	в	Г	Г	т	с	ё
2	*		"	2	B	R	b	r	В	Т	в	г	Д	Д	т	у	ё
3	*		#	3	C	S	c	s	Г	У	г	д	Е	Е	у	ф	ё
4	*		\$	4	D	T	d	t	Д	Ф	д	е	Ж	Ж	ф	х	ё
5	*		%	5	E	U	e	u	Е	Х	е	ж	З	З	х	ц	ё
6	*		&	6	F	V	f	v	Ж	Ц	ж	з	И	И	ц	ч	ё
7	*		'	7	G	W	g	w	З	Ч	з	и	Й	Й	ч	щ	ё
8	*		(8	H	X	h	x	И	Щ	и	й	К	К	щ	ь	ё
9	*)	9	I	Y	i	y	Й	Ъ	й	к	Л	Л	ъ	ы	ё
A	*		*	:	J	Z	j	z	К	Ы	к	л	М	М	ы	ь	ё
B	*		+	;	K	[k	[Л	Ь	л	м	Н	Н	ь	э	ё
C	*		,	<	L	\	l]	М	Э	м	н	О	О	э	ю	ё
D	*		-	=	M]	m]	Н	Ю	н	о	П	П	ю	я	ё
E	*		.	>	N	^	n	~	О	Я	о	п	Р	Р	я		ё
F	*		/	?	O	_	o		П	Я	о	р	С	С			ё

CRO-ASCII

	*	0	1	2	3	4	5	6	7	8	9	A	B	C	D	E	F
0	*				0	Z	P	ž	p	Č	É	á	Л	л	α	≡	
1	*		!	1	A	Q	a	q	Č	Û	æ	í	Г	Г	β	±	
2	*		"	2	B	R	b	r	é	Æ	ó	ó	Д	Д	Γ	≥	
3	*		#	3	C	S	c	s	ā	ō	ú	ú	Е	Е	Π	≤	
4	*		\$	4	D	T	d	t	ä	ö	ñ	ñ	Ж	Ж	Σ	∫	
5	*		%	5	E	U	e	u	à	ò	ň	ň	З	З	σ	∫	
6	*		&	6	F	V	f	v	ä	ü	ě	ě	И	И	μ	+	
7	*		'	7	G	W	g	w	č	ù	ě	ě	Й	Й	τ	≈	
8	*		(8	H	X	h	x	ě	ý	ö	ö	К	К	ϕ	°	
9	*)	9	I	Y	i	y	è	ü	ü	ü	Л	Л	θ	°	
A	*		*	:	J	Z	j	z	è	ü	ü	ü	М	М	Ω	°	
B	*		+	;	K	š	k	š	ì	č	č	č	Н	Н	δ	°	
C	*		,	<	L	š	l	š	í	č	č	č	О	О	ω	°	
D	*		-	=	M	č	m	č	í	č	č	č	П	П	∅	°	
E	*		.	>	N	č	n	č	í	č	č	č	Р	Р	∅	°	
F	*		/	?	O	_	o		í	č	č	č	С	С	∅	°	

12 Control Codes Summary

12.1 ESC/P2 Emulation Command List

Command	Function
BEL	Beeper
BS	Backspace
HT	Horizontal Tab
LF	Line Feed
VT	Vertical Tab
FF	Form Feed
CR	Carriage Return
SO	Double-Wide Printing 1 Line
SI	Select Condensed Mode
DC2	Cancel Condensed Mode
DC4	Cancel Double-Wide Printing 1 Line
CAN	Cancel Line
ESC SO	Double-Wide Printing 1 Line
ESC SI	Select Condensed Mode
ESC SP	Set Inter Character Space
ESC !	Master Select
ESC #	Cancel MSB Control
ESC \$	Set absolute horizontal print position
ESC %	Select user-defined set
ESC &	Define user-defined characters
ESC (-	Select line/score
ESC (B	Bar code setup and print
ESC (C	Set page length in define unit
ESC (G	Select graphics mode
ESC (U	Set unit
ESC (V	Set absolute vertical print position
ESC (^	Print data as characters
ESC (c	Set page format
ESC (t	Assign character table
ESC (v	Set relative vertical print position
ESC *	Select bit image
ESC +	Select n/360" Line Spacing
ESC -	Auto Underscore
ESC .	Print raster graphics
ESC 0	Select 1/8" Line Spacing
ESC 2	Select 1/6" Line Spacing
ESC 3	Set Graphics Line Spacing (n/180")
ESC 4	Select Italic Mode
ESC 5	Cancel Italic Mode
ESC 6	Enable Printable Characters
ESC 7	Enable Upper Control Codes
ESC :	Copy ROM to RAM

Tally Dascom 1140

Command	Function
ESC <	Select Unidirectional Mode 1 Line
ESC =	Set MSB to 0
ESC >	Set MSB to 1
ESC ?	Reassign Graphics Mode
ESC @	Initialize Printer
ESC A	Set n/60" Line Spacing
ESC B	Set Vertical Tabs
ESC C	Set Page Length in Lines
ESC C 0	Set Page Length in Inches
ESC D	Set horizontal tabs
ESC E	Select Emphasized Mode
ESC F	Cancel Emphasized Mode
ESC G	Select Double-strike Mode
ESC H	Cancel Double-strike Mode
ESC J	Advance print position
ESC K	Select 60-dpi graphics
ESC L	Select 120-dpi graphics
ESC M	Select 12 cpi
ESC N	Set bottom margin
ESC O	Cancel bottom margin
ESC P	Select 10 cpi
ESC Q	Set right margin
ESC R	Select an international character set and code page
ESC S	Select Subscript or Superscript Printing
ESC T	Cancel Subscript or Superscript Printing
ESC U	Turn unidirectional mode on/off
ESC W	Turn Double-wide Mode On/Off
ESC Y	Select 120-dpi, double-speed graphics
ESC Z	Select 240-dpi graphics
ESC \	Set relative horizontal print position
ESC c	Set horizontal motion index(HMI)
ESC g	Select 15 cpi
ESC k	Select Typestyle Family
ESC l	Set left margin
ESC p	Turn Proportional Mode On/Off
ESC q	Select Character Style
ESC t	Select character table
ESC w	Turn Double-high Mode On/Off
ESC x	Select Letter Quality or Draft
ESC y	Select draft/super draft
ESC Y	Select High-speed Double-density Graphics Mode
DEL	Delete Character

12.2 IBM Emulation Command List

Command	Function
BS	Backspace
HT	Horizontal tab
CR	Carriage return
ESC BS	Backspace
ESC HT	Horizontal tab
ESC CR	Carriage return
ESC D	Set horizontal tabs
ESC X	Set horizontal margins
ESC d	Relative mode inline forward
LF	Line feed
VT	Vertical tab
FF	Form feed
ESC LF	Line feed
ESC VT	Vertical tab
ESC FF	Form feed
ESC 0	Select 1/8" line spacing
ESC 1	Select 7/72" line spacing
ESC 2	Start text line spacing
ESC 3	Set graphics line spacing
ESC 4	Set top of form
ESC 5	Automatic line feed
ESC A	Set text line spacing
ESC B	Set vertical tabs
ESC C	Set form length in lines
ESC C NUL	Set form length in inches
ESC J	Graphics variable line spacing
ESC N	Set automatic perforation skip
ESC O	Cancel automatic perforation skip
ESC [\	Set vertical units
ESC]	Reverse line feed
SO	Double-wide printing by line
SI	Condensed printing
DC2	Select 10 cpi
DC4	Cancel double-wide printing by line
ESC SO	Double-wide printing by line
ESC SI	Condensed printing
ESC DC2	Select 10 cpi
ESC DC4	Cancel double-wide printing by line
ESC -	Continuous underscore
ESC :	Select 12 cpi
ESC E	Select emphasized mode
ESC F	Cancel emphasized mode

Tally Dascom 1140

Command	Function
ESC G	Select double strike mode
ESC H	Cancel double strike mode
ESC I	Set print mode
ESC P	Proportional space mode
ESC S	Start subscript or superscript printing
ESC T	Cancel subscript or superscript printing
ESC W	Continuous double-wide printing
ESC [-	Score select
ESC [@	Set presentation highlight
ESC [I	Set font global
ESC [d	Set print quality
ESC _	Continuous over score
ESC 6	Select character set 2
ESC 7	Select character set 1
ESC =	Character font image download
ESC [T	Set code page
ESC \	Print continuously from all character chart
ESC ^	Print single character from all character chart
ESC K	Normal density bit image graphics
ESC L	Dual density bit image graphics
ESC Y	Dual density bit image graphics
ESC Z	High density bit image graphics
ESC [g	High resolution graphics
ESC [f	Setup barcode parameter
ESC [p	Set barcode data
DEL	Beeper
DC1	Select printer
DC3	Deselect printer
CAN	Cancel Data
ESC BEL	Beeper
ESC DC1	Select printer
ESC DC3	Deselect printer
ESC CAN	Cancel Data
ESC Q	Deselect printer
ESC R	Set all tabs to power on settings
ESC U	Set print direction
ESC [K	Set initial condition
ESC j	Stop printing
ESC *	Select graphics mode
ESC 3(AGM)	Set graphics line spacing(n/180")
ESC A(AGM)	Set text line spacing(n/60")
ESC J(AGM)	Graphics variable line spacing(n/180")

FCC STATEMENT

Changes or modifications not expressly approved by the responsible for compliance could void the user's authority to operate the equipment.

NOTE: This equipment has been tested and found to comply with the limits for a class B digital device, pursuant to Part 15 of the FCC Rules. These limits are designed to provide reasonable against harmful interference in a residential installation. This equipment generates, uses and can radiate radio frequency energy and, if not installed and used in accordance with the instructions, may cause harmful interference to radio communications. However, there is no guarantee that interference will not occur in a particular installation. If this equipment does cause harmful interference to radio or television reception, which can be determined by turning the equipment off and on, the user is encouraged to try to correct the interference by one or more of the following measures:

- Reorient or relocate the receiving antenna.
- Increase the separation between the equipment and receiver.
- Connect the equipment into an outlet on a circuit different from that to which the receiver is connected.

Consult the dealer or an experienced radio/TV technician for help.

DASCOM REPRESENTATIVES

GERMANY

DASCOM Europe GmbH
Heuweg 3
D-89079 Ulm
Deutschland
Tel.: +49 (0) 731 2075 0
Fax: +49 (0) 731 2075 100
www.dascom.com

UNITED KINGDOM

DASCOM GB Ltd
Hart House, Priestley Road,
Basingstoke, Hampshire
RG24 9PU, England
Phone: +44 (0) 1256 481481
Fax: +44 (0) 1256 481400
www.dascom.com

SINGAPORE (ASIA PACIFIC)

DASCOM AP Pte Ltd
21 Bukit Batok Crescent
#29-81, WCEGA Tower
Singapore 658065
Phone: +65 6760 8833
Fax: +65 6760 1066
www.dascom.com

AMERICAS

Dascom Americas Corporation
34 Lakeview Court
Verona, VA 24482
USA
Phone: +1 (877) 434 1377
Fax: +1 (540) 242 7221
www.dascom.com

FRANCE

DASCOM Europe GmbH
117 Avenue Victor Hugo
92100 Boulogne-Billancourt
France
Phone: +33 (1) 73 02 51 98
www.dascom.com

CHINA

JIANGMEN DASCOM COMPUTER
PERIPHERALS CO., LTD
No.399, jinxing Road,
Jianghai District Jiangmen,
P.R. China
www.dascom.com

"All rights reserved. Translations, reprinting or copying by any means of this manual complete or in part or in any different form requires our explicit approval. We reserve the right to make changes to this manual without notice. All care has been taken to ensure accuracy of information contained in this manual. However, we cannot accept responsibility for any errors or damages resulting from errors or inaccuracies of information herein."